

Installation Instructions
Marine Water Heater

***Thermo Pro 90 Water Heater Kit
Diesel 12 & 24v - English***





Feel the Drive

Thank you for choosing Webasto Marine Central Heating

We are certain that you will enjoy many years of satisfactory service from your Webasto product. Should you require any assistance our approved distributor and national dealer network are always at your service.

Happy Boating!

For Technical Advice and Spare Parts in the UK, please contact one of the following Approved Webasto Marine Main Distributors:

East (England)

J.P.C. Limited
Staithe Way Road
Wroxham, Norwich
NR12 8RN
Tel : 0870 770 2676
Fax : 01603 784295
sales@jpcdirect.co.uk

Scotland

BOATCRAFT
Clyde Marina
Ardrossan
KA22 8DB
Tel: 01294 603047
Fax: 01294 607076
info@boatcraft.info

Ireland

CH Marine
Nautic House, Marsh Road
Skibbereen
Co Cork
Tel: 00 353 28 23190
Fax: 00 353 28 22028
info@chmarine.com

Midlands / North West

Kings Lock Chandlery
Booth Lane, Middlewich
Cheshire
CW10 0JJ
Tel: 01606 737564
Fax: 01606 737551
sales@kingslock.co.uk

South (England) / Wales

Keto Ltd
25 Albany Park
Cabot Lane
Poole
BH17 7BX
Tel: 01202 690900
Fax: 01202 691900
info@ketogroup.com

Midlands

Evesham Marina
Kings Road
Evesham
Worcs.
WR11 3XZ
Tel: 01386 768500
Fax: 01386 761094

North East (England)

Selby Boat Centre
Bawtry Road
Selby BH17 7BX
North Yorkshire
YO8 8NB
Tel: 01757 212211
Fax: 01757 212211
enquiries@selbyboatcentre.co.uk

Webasto Product UK Ltd

Webasto House, White Rose Way Doncaster Carr, South Yorkshire, DN4 5JH

Telephone (01302) 322232 Fax (01302) 322231

E Mail Address: info@webastouk.com

Website Address : www.webasto.co.uk

Warranty

Your Webasto heater is covered by a full manufacturer's warranty covering defects caused by faulty manufacture. This warranty period is 36 months from the point of purchase.

Claims cannot be accepted where faulty installation has caused failure.

The warranty does not cover damaged through water ingress, external force, incorrect installation or misuse.

Repairs, both during and after the warranty period, should be carried out by an authorised Webasto dealer only. Claims for repairs carried out by other than an authorised Webasto dealer cannot be accepted.

These conditions do not affect your statutory rights.

If you have any doubts as to who is your local dealer, please do not hesitate to call Webasto. We will inform you of your local dealer, who will be pleased to give you any further information with regards to your heater, or carry out any work or repairs you may require.

All warranties are subject to the specific exclusions detailed below:

Bulbs, line fuses, fuel filters, overheat fuses, drive belts, glass panels, refrigerant, receiver drier and lubricants. (Unless their loss, damage or failure has been caused by a defect that falls within the scope of the warranty cover as detailed above).

Glow plugs, burners, gaskets and seals normally replaced during routing servicing, will not be covered by the warranty, either to qualify for, or within the duration, of any specific warranty period.

Travelling time and mileage incurred in order to affect repairs (unless the installation of the product is such that it cannot practically be taken to an authorised repair centre).

These exclusions also preclude any claims for labour associated with the diagnosis, or repair, of any defects falling wholly within the scope of the exclusions.

Warranty cover does not apply if the product was not correctly installed (except as detailed above); is used for any purpose other than that for which it was designed; has been subject to misuse or neglect any way; has been modified without the prior approval of Webasto Thermo & Comfort UK Ltd; has been fitted with non-genuine parts; or has been serviced or repaired other than a person approved by Webasto Thermo & Comfort UK Ltd.

Warranty cover commences upon the date of purchase of the product, or of the equipment into which the product is installed from new. All warranty claims must be presented with proof of purchase of the product.

SERVICE

Don't guess ... seek advice!

Your local authorised Webasto dealer will be pleased to help. Check first to determine whether 'call out' charges may be applicable.

Regularly check your Webasto heating system for the following points:-

- Corrosion on electrical terminals ... clean and spray with an inhibitor as necessary
- Clean running at the exhaust ... if not, call an authorised Webasto dealer
- Ensure that the exhaust outlet and combustion air intake are 'free' and not blocked or damaged ... repair or replace as required.
- Ensure sufficient water is in the header tank if a tank is used, or check the system pressure gauge if a the heater is fitted to a pressurised system. Do not let either type of system run dry.
- Periodically check the water specific gravity and top up as required with a 75% water 25% anti-freeze mix .
- Run your heating system during the summer, if only for a few minutes each month, to check that it is operating satisfactorily and to avoid 'old' diesel collecting in the fuel lines. This avoids acidity which can destroy components.

Every alternate season, it is recommended that an authorised Webasto dealer tests the heater system, and if required, any carbon deposits can be removed from the heat exchanger.

If the heater takes in sea water or water from a hose whilst cleaning the boat, - seek the advice of a Webasto dealer immediately.

Technical Data for Thermo Pro 90 12v & 24v

Thermo Pro 90		
Parameter	Value	
Variants	Diesel	
Approval		
Approval number ECE R122 (heating)	E1 00 0320	
Approval number ECE R10 (EMC)	E1 03 6196	
Functional Characteristics		
Heating capacity control range / max. [kW]	1,8 - 7,6 / 9,1	
Fuel control range / max. [l/h]	0,2 - 0,9 / 1,1	
Nominal voltage [V]	12	24
Operating voltage range [V]	10,5 – 15,5	20 – 31,5
Nominal power consumption with coolant pump control range / max. [W]	37 - 83 / 90	
Fuel, released	Diesel according to DIN EN 590	
Fuels, tested for compatibility	FAME according to DIN EN 14214 Heating oil (EL) according to DIN 51603-1 NATO fuels F34, F58 and F63	
Dimensions L x W x H [mm]	355 x 131 x 224	
Weight incl. control unit and U4840 [kg]	4,9	
Additional Product Data		
Lifespan [h]	5000 operating hours	
Permissible operating temperature [°C]	-40 to +80	
Combustion air intake temperature [°C]	-40 to +40	
Storage temperature [°C]	-40 to +125	
Minimum capacity of the coolant circuit [l]	6	
Approved operating pressure	min. 0,4 – max. 2,0	
CO ₂ emission in the functional range [%]	9 - 11,5	
CO emissions [ppm]	< 1000	
Sooting number (according to Bacharach)	≤ 3	

Heater Operation

Check that the battery master switch is 'ON'.

Select the 'ON' position using the heater's ON/OFF switch. The green operating indicator light will illuminate in the switch.

The heater first carries out a diagnostic check of its components. If a fault is present, the heater will perform a purge cycle, during which the combustion air motor and water pump will run for 180 seconds and the green operation light will flash a fault code. (Refer to fault diagnosis).

A successful diagnostic check is followed by glowpin operation. For a period of 25 seconds, the combustion chamber is pre-heated by the glowpin, followed by the fuel pump operation and the combustion air fan automatically being switched on. (If the heater fails to start within 2 minutes, a second cycle will commence automatically).

Combustion will now commence and the glowpin will be switched off by the heater control unit. A gradual increase in motor speed will then take place until the heater is running at full power (9.1kW).

When the water temperature reaches 72°C, the heater will switch to a lower output. The combustion air motor speed and fuel pump delivery are reduced.

If the coolant temperature continues to rise by a further 10°C, the heater will then automatically stop combustion, fuel delivery will cease and the flame within the combustion chamber will be extinguished. The heater will then commence a controlled shutdown cycle.

The heater is now in stand-by mode. The green operation light will still be illuminated and the water pump will continue to circulate the hot water. The heater will automatically restart if the water temperature falls by 15 C, going through the same start cycle as before.

When the ON/OFF switch is turned to the 'OFF' position, the fuel pump will stop delivering fuel to the heater, causing the combustion within the heater to cease. A purge cycle of 180 seconds will allow the heater to cool down before finally switching off. **DO NOT ISOLATE THE BATTERY UNTIL THE PURGE CYCLE IS COMPLETED, AS DOING SO COULD CAUSE DAMAGE TO THE HEATER.**

The heater system has a low voltage lockout system built into the control unit. This will protect the vessel's battery should it drop to a low state of charge. Operation of the engine and alternator should eradicate any such problems.

The Thermo Pro 90 Marine Kit incorporates a diesel powered 9.1kW water heater, with a capability of a variable heat output, down to a reduced heat level of 1.8kW. Heated water is supplied to the vessel's heating circuit, consisting of either household radiators or automotive style blower boxes, an option of domestic hot water is also possible with the use of a calorifier.

The heater burns diesel fuel supplied from the vessel's main tank, the correct amount of fuel being measured and drawn by the dosing pump prior to delivery to the heater's combustion chamber.

On arrival in the combustion chamber, the fuel is vaporised off unique 'Ferro-Tech' burner, initially being ignited by a glowpin. Following starting the heater, combustion is sustained by the continuous vaporisation of the metered fuel delivery.

Combustion takes place within a sealed heat exchanger and the exhaust gases are ducted to the vessel's side or transom, via a stainless steel flexible pipe and skin fitting.

Components and Connections

1	Control unit	12	Coolant inlet
2	Combustion air fan motor	13	Coolant pump
3	Fuel line	14	Metal fiber evaporator
4	Glow plug	15	Exhaust outlet
5	Fuel pump	16	Exhaust gas temperature sensor
6	Coolant outlet	17	Combustion air fan impeller
7	Coolant temperature sensor	18	Combustion air inlet
8	Combustion chamber	19	Magnet (at blower wheel)
9	Exterior of heat exchanger	20	Height sensor
10	Overheating protection	21	Hall-sensor
11	Heat exchanger		

Meanwhile the heater's integral water pump circulates cool water from the heating into the heat exchanger, where it is heated and reintroduced — Hot — into the heating system to heat the radiators etc.

Operation of the heater is via an ON/OFF switch or an optional digital timer, which can be sited in the main cabin area.

If blower boxes are used, an optional thermostat control system is available to regulate the cabin temperature.

For maximum safety, the heater has various sensors which will shut down the heater should they be activated.

These heaters are not solely used on boat but are supported by a pedigree of military, truck, car, luxury coach and a variety of other applications.

The Thermo Pro 90 Marine Kit is designed specifically for marine users, incorporating the high technical specifications required by the Marine Industry.

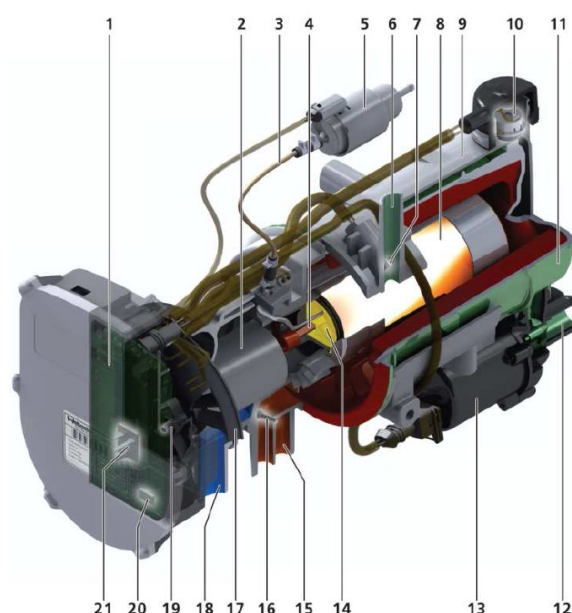

Positioning of the heater

The heater requires a dry, protected area, which will not be adversely affected by seawater, excessive vibration or fumes.

The location of the heater must be well clear of any gas storage or delivery lines. When choosing the position, bear in mind stowage, conduits and service access points, steering gear linkages etc. It is also important to consider the required installation features for the heater:

1. Exhaust maximum length
2. Exhaust outlet point
3. Combustion air maximum length
4. Combustion air inlet point
5. Access for heater pipes
6. Fuel pick-up point
7. Electrical supply

The engine room is a favoured position, where fuel, combustion air and access to the hull for the exhaust are all at hand. Avoid impinging upon stowage space or placing the heater where sails may rest on the hot exhaust system. Mount the heater level so as to avoid forming air pockets inside the heat exchanger if possible.

Permissible mounting orientations are shown below

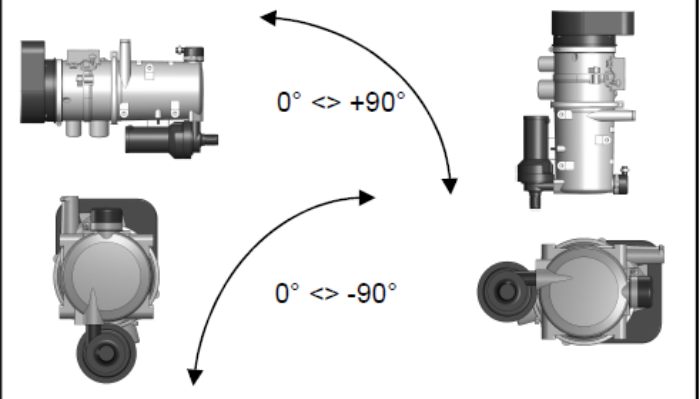

Do not mount the heater as shown below

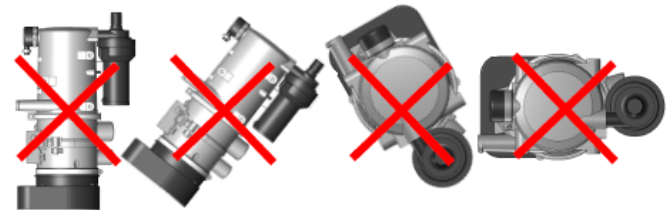

If the heater is mounted in these orientations air will be trapped inside the heat exchanger.

Figure 1

Typical Water Heater System

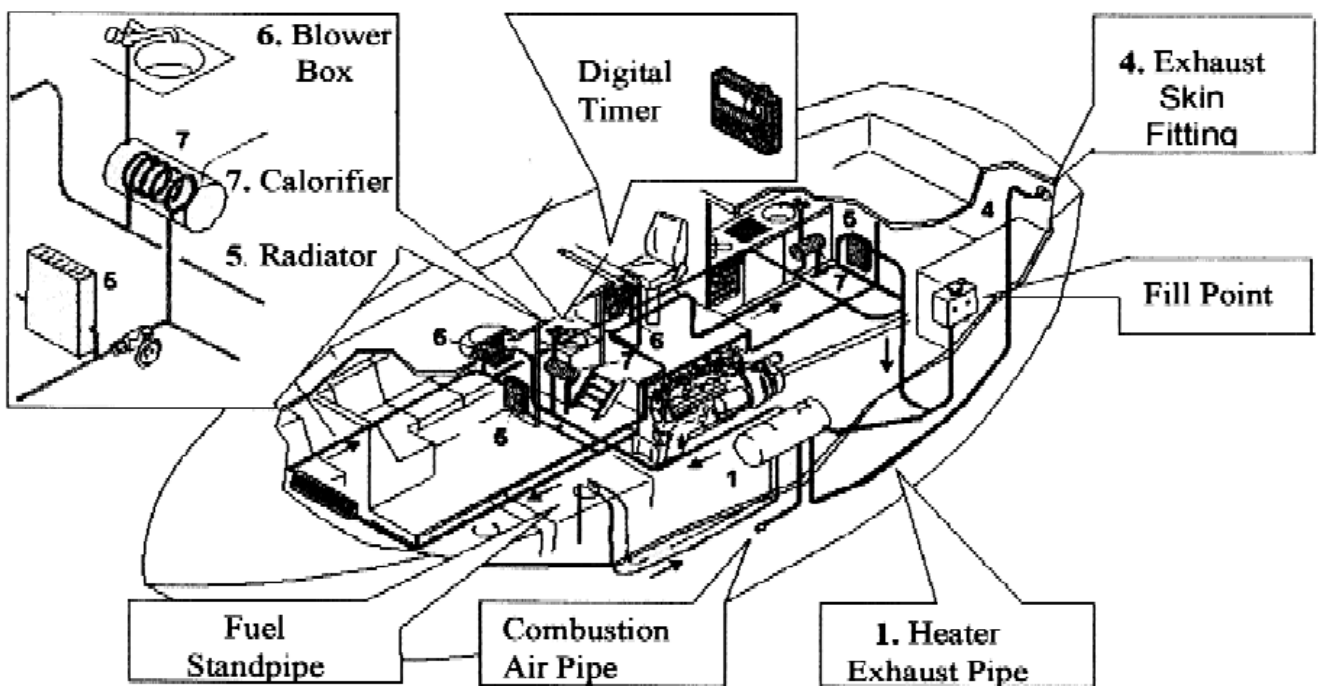

Exhaust System



Feel the Drive

Length of the combustion air inlet & exhaust lines in total:

With exhaust silencer: max 5.0m
 Silencer must be fitted close to heater.

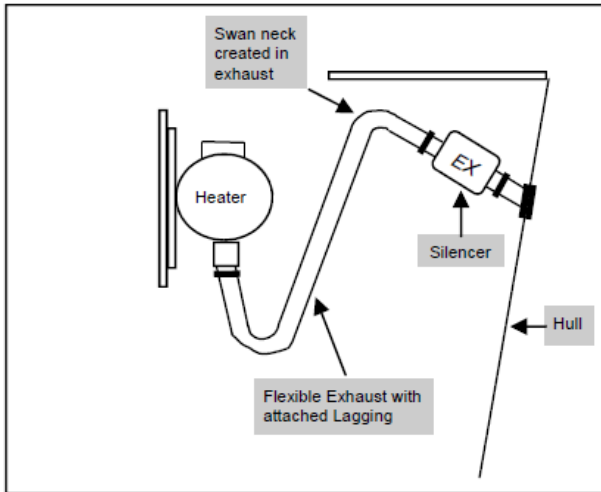
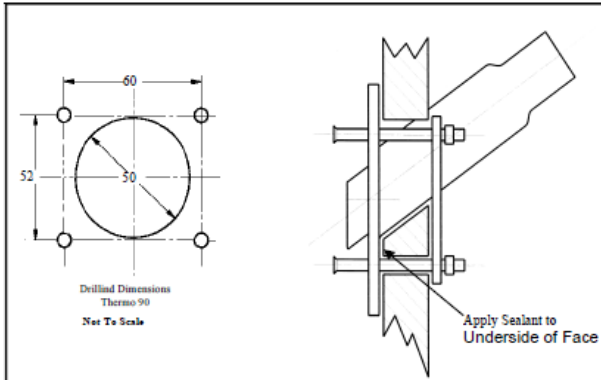

Exhaust Connection - Typical

Create a swan neck in the exhaust to prevent water ingress. The heater requires a dry exhaust, not water injected.

Minimum bend radius exhaust: >85mm

Total bends

Combustion air pipe: max 360°

Exhaust pipe: max 360°

For every 90° of bend in combustion air and exhaust pipes the exhaust system total length must be de-rated by 500mm.

The exhaust from the heater must not be connected to any other exhaust system.

Route the flexible exhaust, securely attached in such a way that the heat cannot affect adjacent plastic piping, electric cables etc.

The exhaust pipe should be wrapped in the woven glass protective sock and secured with stainless ties supplied with the kit. If additional protection is required, over-wrap with woven glass tape available from your Webasto Dealer.

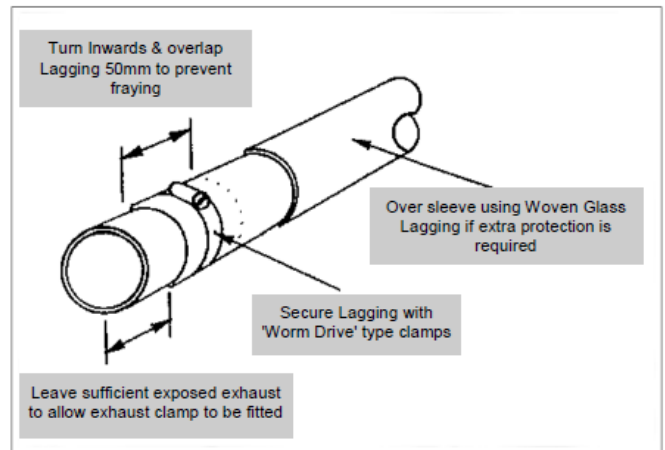

Exhaust Insulation

The skin fitting is normally fitted on the transom or cockpit combing. The hull side is acceptable for motor boats, but bear in mind the bow wave line and beam sea risk. It must also not point in the direction of travel, or be susceptible to high land wind pressure, which may blow out the flame within the heater.

Measure the diameter of the skin fitting to be fitted and cut the hole using a hole saw. A suitable pilot hole should be drilled first!

- ❖ Do not fit the skin fitting below the water line.
- ❖ Do fit the skin fitting as high as possible to stop water ingress
- ❖ Do make sure that exhaust clamps are tight to avoid gas leakage
- ❖ Do make sure the exhaust gasses cannot reach the combustion air intake
- ❖ Do not cover the exhaust with the heater running.

We recommend the application of a suitable high temperature sealant being used on all the exhaust connections sufficient to fill the corrugations in the flexible pipe ONLY but not enough to block or impair the exhaust system.

We recommend the use of Webasto PC diagnostics to verify the exhaust emissions of the installation. Your local Webasto agent can supply this instrument or may be able to offer a commissioning / calibration service.

For CO2 emissions refer to the table of specifications in this book.

FUEL CONNECTION

If you are installing the heater to Lloyds specifications, Specialist advice should sought.

The Fuel system conforms to ISO 7840 & the Inland Waterways specifications when installed correctly as detailed. Always ensure only clean fuel is used. The heater is designed to run on EN590 Diesel & BS2869A2 Gasoil.

The use of fuels containing high levels of sulphur, water or other contaminants may increase the service interval required.

Several specific regulations apply including the use of flame resistant fuel pipe such as copper pipe, and fire resistant fixings. Use a sharp pipe saw and NOT a hacksaw if the supplied copper pipes are to be shortened. If the pipes are shortened the pipe ends must be re-flared with a suitable flaring tool as per the picture to the right. Ensure afterwards that the bore of the pipes are still 2mm. Use a 2mm drill bit as a gauge. Connect the flared copper pipes with the small black ISO7840 hose pieces to the Fuel Pump, Heater, Standpipe and other fuel system parts that have a barbed nipple connection and secure with worm drive clamps.

The best technique is to fit the rubber pipes on to the standpipe, fuel pump and the heater nipples and then insert the copper pipe flared ends fully into the other ends of the rubbers. The reason for this is to ensure there are no gaps inside the rubber pipes that could harbour air pockets as shown below. Apply a dab of diesel to the pipe ends before assembly. This will make the installation easier and reduce the likelihood of the bore of the rubber pipe being torn and causing a blockage.

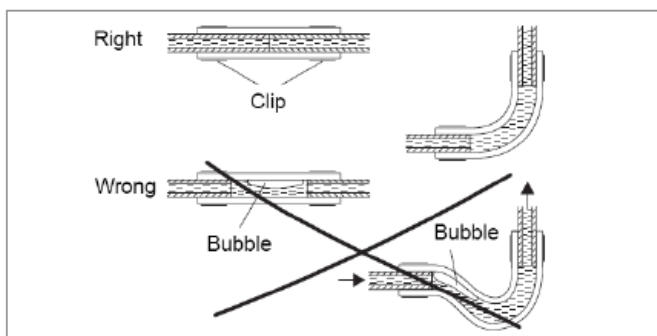

Illustration of how to insert a copper pipe into a rubber joiner.

If other pipe fittings are needed due to different fuel supply arrangements i.e. in-line filters or water traps etc other than those supplied these can be obtained from your Webasto Dealer.

Webasto

Feel the Drive



Flared end of copper pipe

Follow the diagrams below for connecting the fuel supply and positioning the components, noting the mounting parameters, for the fuel pump, which are critical to ensure correct operation of the heater. Mount the fuel pump using the "P" clip according to Pump Diagram. Ensure the correct direction of flow is observed. Depending upon the quality of fuel used and the point where the fuel is extracted from the vessels fuel system, an additional water separator and or fuel filter may be required prior to the dosing pump.

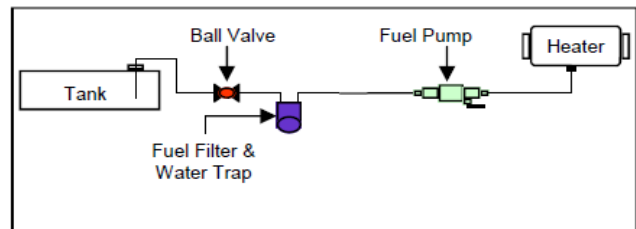

Fuel Supply System - Typical

The Ball Valve, Filter / Separator are optional and may not be part of your kit. All optional parts mentioned are available from your Webasto Dealer.

The copper fuel pipe used in the system should be:
2 mm Inside Diameter
5 mm Outside Diameter

The copper pipe supplied with the kit meets this standard.

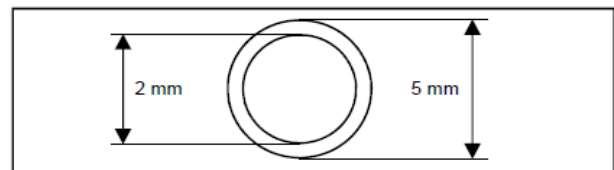

Fuel pipe dimensions

Ensure that the 2mm I.D. - 5mm O.D supplied copper pipe is used.

If you fit any additional filter or valves in the fuel system make sure the pipes / hoses are flared copper and are connected with ISO7840 50mm long hose sections clamped at each end.

FUEL CONNECTION (Continued)

The suction hose length, (Fuel Tank to Fuel Pump) including the pick up pipe length, (if applicable) should be no longer than 1.20m, use the 1.2m copper pipe supplied.

The maximum height of the Heater above the Fuel Pump should be no more than 3.0m.

The Fuel Pump Must NOT be mounted above the heater or any exhaust pipe.

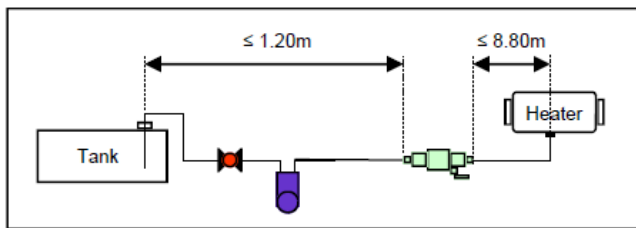

Fuel System - Pipe Maximum Lengths

All fuel lines must be correctly installed and securely mounted and protected against heat, impact and abrasion damage.

Fuel Pump mounting orientation is critical to correct performance. Mount horizontally using the anti vibration clip with electrical connector inlet orientated upwards as shown in drawing below. Do not mount close to heat sources, (engines or exhausts). Ensure pump is mounted to avoid mechanical damage. The pump must not be mounted more than 3m below the heater. Refer to the drawing below for the correct heights etc.

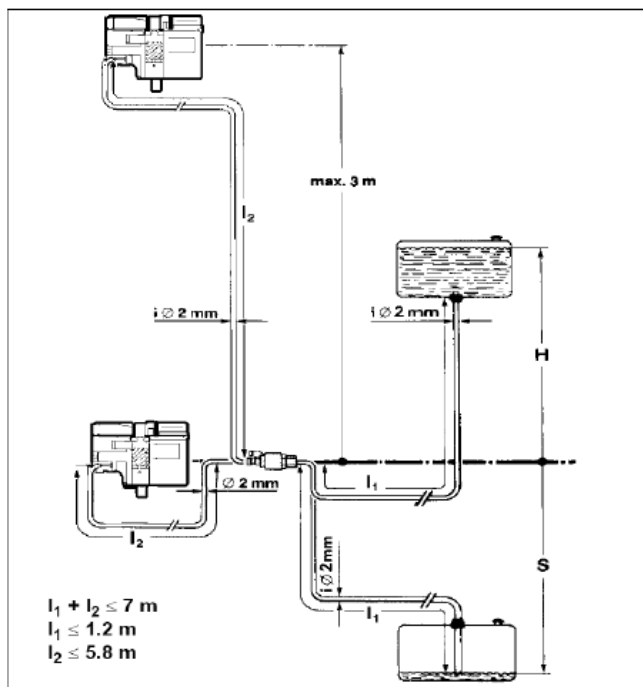

Fuel System - component heights

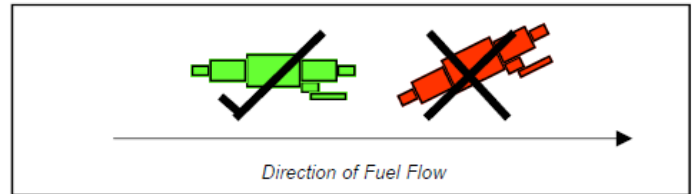

Fuel Pump Orientation

Ensure the fuel lines are installed securely with rubber lined P-Clips and routed in such a way that they will not suffer from mechanical damage.

Do not install the fuel lines adjacent to any heat source. Do not clip the fuel lines to any exhaust system. Do not clip any wiring harness or cable to the fuel lines. When routing the pipes try to avoid forming tight angles in the copper pipe. All bends must be gentle and sweeping with a large radii.

FUEL STANDPIPE CONNECTION

When fitting the Webasto standpipe drill the fuel tank using a "25mm" hole saw, or using a cone cutter in preference to filing. **Note:** before drilling, grease the top of the fuel tank around the intended drilling area to collect any swarf which will be present.

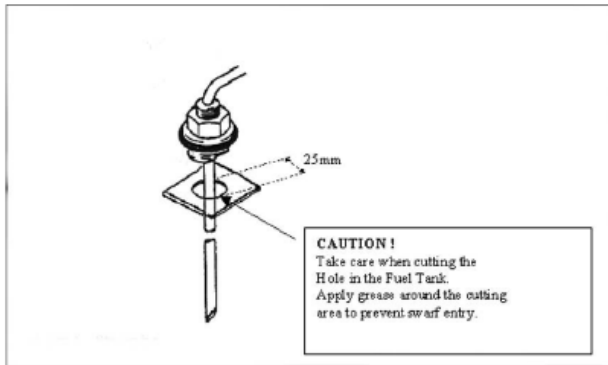

Webasto Standpipe

Ensure that the aforementioned guidelines are referred to when choosing the positions of components, such as the heater and fuel pump.

Link the fuel supply from the standpipe to the fuel pump and from the pump to the heater using the copper Fuel pipe with the black hose sections as unions as described previously. Remember to Flare the copper pipe ends if any pipes have been shortened. Remove any burrs from the Fuel pipe using a small file and blow any swarf out of the pipes prior to fitting.

Lay the fuel pipe straight, preferably running gently upwards towards the heater to ease the bleeding of any air in the fuel line. Avoid tight radius pipe bends as these cause a resistance in fuel flow. It is preferable to have a wide radius bend.

Securely clip the pipes at frequent intervals, away from any heat source.

Please note if any other pipe fittings or inline Valves or Filters etc are fitted into the fuel line that contain compression fittings make sure they do not contain brass olives as these are too brittle. Only use copper olives. When using copper olives there is less chance of distorting the copper pipe.

If the supplied standpipe is too long for the fuel tank ascertain the correct length, (normally 4~5 inch from tank bottom) then using a very sharp knife blade score the pipe diameter and snap the excess off.

Ensure the standpipe is leak free after installation.

Webasto
Feel the Drive

It is possible to use instead of the Webasto standpipe a piece of pipe that complies with the Webasto standard of 5mm OD & 2mm ID. Below is a picture of how this can be achieved using readily available parts.

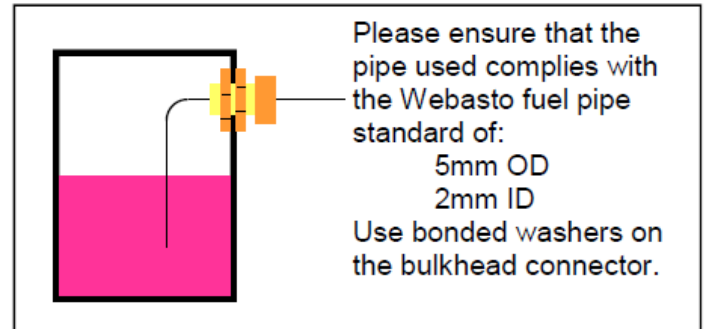

Alternative Standpipe

A suitable hole needs to be drilled to suit either a through bulkhead connector or a weld in place threaded 'bush'. If a bulkhead connector is used, use bonded washers, (doubtless seals) between the metal of the tank and the connector shoulder.

If it is decided to weld in a bush, make sure the male insert has a tapered thread.

Thread a piece of pipe to the specification detailed above through the fitting into the fuel tank. Bend at 90 degrees taking care not to kink the pipe and collapse the internal bore.

Tighten up the nut and olive to secure the connection. Do not over tighten the fitting and crush the pipe.

A fuel resistant thread sealant must be used on both options. Do not use PTFE tape!

Ensure the penetration into the fuel tank is leak free afterwards.

COMBUSTION AIR INTAKE

Do not extract combustion air from passenger compartments.

The heater is supplied with a 1160mm length of combustion air pipe. This should be placed in such a position to provide dry, cool air to the heater unit.

If mounted in the engine room, ensure that no foreign bodies enter the intake pipe.

Do not let the pipe hang down if a potential exists for bilge water to enter the pipe if the vessel heels over in heavy seas.

The combustion air pipe supplied is the maximum length permitted and should not be extended.

Do not extract combustion air from the vessel's engine air intake or filter system.

Fit the round black combustion air pipe trap to the end of the pipe and securely mount.

PLUMBING OPTIONS WATER (PRESSURIZED)

Webasto recommend that the heater is fitted to a pressurised heating circuit and gravity fed header tank systems are avoided. This is because in a marine application it is difficult to provide an adequate head of pressure due to the lack of space for a reasonable size tank and finding a high enough position.

Examples of typical Pressurised plumbing arrangements.

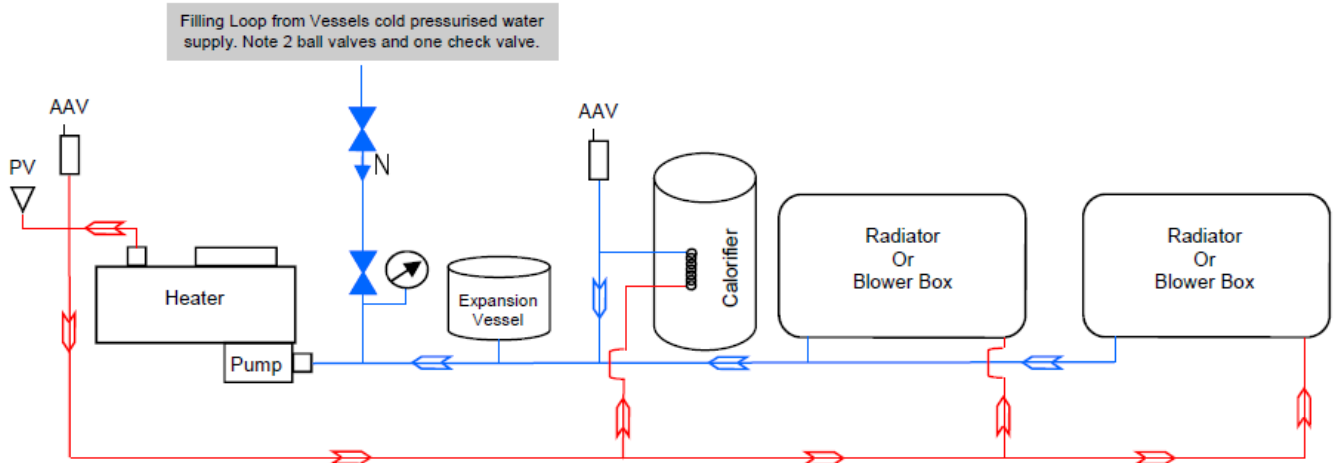

Example 1. Typical Pressurised system using Auto Air Vents - (AAVs).

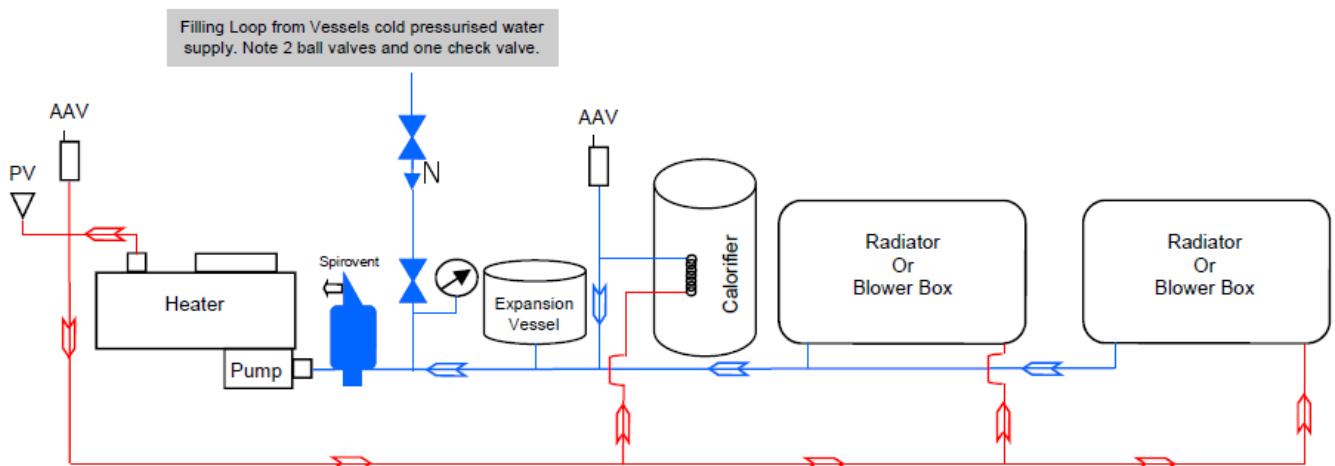

Example 2. Typical Pressurised system using Auto Air Vents - (AAVs) & Spirovent

Note the inclusion of the Pressure Relief valves, (marked as PV). One of these should be mounted in the hot water outlet pipe no more that 30cm away from the heater. Preferably at a high point.

PLUMBING OPTIONS WATER (PRESSURIZED)

Example 1. Pressurised system with AAV's

This is the most efficient, reliable and robust system and is most suitable for a marine installation. There is no need for a header tank to be fitted and therefore radiators can be installed at any height in any position. This is especially useful when installing a system in a boat with decks on different levels.

The air purging and filling process is very easy and straight forward.

There is no need to top up any header tanks.

To charge the system a 'filling loop' or connection to the vessels pressurised water system is required. As indicated in the drawing, two ball valves and a non return valve are required so as to prevent any glycol contamination of the vessels cold water supply.

An expansion tank is connected via a T piece to the return spine close to the circulation pump return. This tank has inside a rubber bladder that should be delivered pre charged to 3 bar. In between the above mentioned tank and pump, the 'filling loop' is Teed into the return spine also, as seen in the diagram.

A pressure gauge is fitted to indicate the system pressure.

When filling this system for the first time proceed as follows.

Pre mix the water / glycol.

Remove one of the vent caps from each radiator, (the threaded boss that holds the bleed screw on the radiator). One radiator at a time.

Make sure both the valves on each radiator are fully open.

Carefully fill each radiator as much as you can with this pre mixed fluid and replace the threaded boss on each radiator. Now the system should be almost full.

With the filling loop connected open both the valves on the filling loop pipe and watch the pressure gauge. Fill to 1 bar (14.5psi). You will probably hear air escaping from the auto air vents, this is normal.

Now the system is under pressure, open each radiator in turn and bleed any trapped air.

Recharge and repeat as necessary.

Switch on the heater so the pump is circulating and check the pressure gauge and recharge the water system up to 1 bar if required.

Ensure both the valves on the filling loop are turned OFF when filling has been completed.

DO NOT overcharge the system above 1 BAR (14.5 psi) when cold.

It is normal when the system is up to full operating temperature for the pressure to rise up to 1.5 BAR (21.75psi) \pm 5%.

Example 2. Pressurised with AAV's & Spirovent

Exactly the same system as above but with the addition of a Spirovent unit that will remove the micro bubbles quicker than AAV's alone.

PLUMBING OPTIONS WATER (HINTS & TIPS)

In order for the heater to work effectively a few simple rules need to be adhered to.

The heating circuit the Webasto is connected to is very similar to a domestic installation with a hot water cylinder and radiators but with a few subtle differences.



Supplied Water Pump.

The water circulation pump is physically small compared to a domestic pump such as those made by Grundfoss or Wilo and consequently the flow rates are smaller also. It is not permitted to fit a larger capacity pump, the supplied pump must be used. The supplied pumps flow characteristics are matched to the heaters thermal transfer properties.



Do not use Thermostatic Radiator Valves.

Only use standard lock shields on the radiators. TRV's will cause differential pressure problems that will effect the balance of the water flow and consequently have an effect on the heater with regards short cycling.



Correctly load the heater.

On a panel radiator only system using for example a 10kw heater the required load needs to be 10-12kw, (+10/20%).

On a system that is using only blower boxes the required load of a 10kw heater needs to be 15-16kw, (+50/60%).



Minimum volume of coolant

For safety reasons an absolute minimum of 10L of coolant is needed in the heating circuit. Ideally 20L of coolant would be needed in a T90ST system, this will reduce heater short cycling and extend the heaters lifespan.



Balance the system

Balance the radiators with the lockshields and remember to fit a lock shield / balancing valve to the Calorifier coil outlet pipe. Also, do not pipe the Calorifier in series with the spine.



Additives

Please do not add any additives to the water cooling circuit. The only things that are permitted inside the heaters hot water circuit are : Water and Glycol. Do not add any additives for instance 'leak cures' or other 'plumbing fixes in a bottle'. It's a pointless exercise fixing symptoms, fix the problem. If you have a leak then you need to fix the leak!

PLUMBING OPTIONS WATER (HINTS & TIPS)



Glycol, (Antifreeze) Percentage of concentration.

As with any type of water heating system it is necessary to add some kind of corrosion inhibitor. In the case of Webasto diesel marine water heaters we use ethylene glycol otherwise known as glycol or antifreeze. The antifreeze must be glycol and NOT methanol based. The other important issue to remember is using the correct quantity. For Webasto heating systems we recommend a glycol content of 25% maximum. The reason we need to add glycol to the heating circuit is to prevent corrosion and freezing. The only drawback to using glycol is that it is not a very good vehicle for carrying heat so we only use 25% maximum. It is the water that gets hot and not the glycol. If we used 100% glycol the radiators would take an extremely long time to get up to temperature if at all!



Glycol Pre-Mixing.

Be absolutely sure to pre mix the glycol & water before filling the system as the glycol will not mix on its own without assistance. If the glycol is not pre mixed there will be slugs of hot water and cool glycol circulating around the system.



Types of Pipe.

If you are going to use Hep20 pipe then use Hep20 fittings and pipe liners. Likewise if you are using JG Speedfit use JG Speedfit fittings. Do not mix and match different brands. Chrome pipe should be avoided when using any push fit pipe fittings. The problem with chrome is that it is an extremely hard metal and the push fit fittings cannot bite into the chrome and consequently when they are under pressure they will pop off and you will get wet.



Pipe Preparation.

Use the correct tool to cut the pipe, copper pipe use a pipe saw, plastic pipe use a plastic pipe cutter such as those made by Hilmor. Do not use a hacksaw.

If plastic pipe is used then always fit the push in liners.

When the heating circuit is completed, prior to connection to the heater make up some temporary tails and affix to the heating spine to flush out any installation debris / dirt that may have found its way into the system.



Bleed the water system

Ensure that all the air is bled from the water circuit and re-pressurise the system back to 1 bar once the air has been expelled.

ELECTRICS



Feel the Drive

Each marine kit wiring harness has been designed to suit the heaters specific requirements. It is therefore not recommended that modifications to the wiring harnesses are carried out without prior consultation with Webasto's technical department.

It is essential that all electrical connections are installed correctly. Loose or dirty connections will cause high resistance in the wiring. This in turn may cause under voltage at the control unit

1 Fuel pump harness

Two core cable from the heaters control box to the fuel pump. One of the plugs is supplied loose and will need to be fitted to the fuel pump end.



2 Fusebox harness

3 way fuse box with one length of red wire that connects to the battery positive. The main harness connects to the bottom of the fuses.

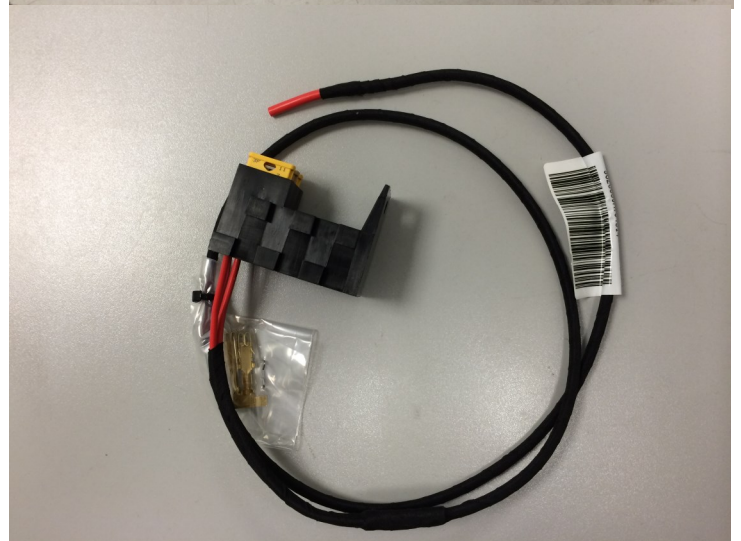

3 Main harness

Large multicore harness with a large connector on one end that plugs directly into the heaters control box. There is also a small plug that is to be left unconnected, this is the diagnostics connection.



ELECTRICS (continued)

4. Vehicle Blower harness

A two core cable consisting of a red and black wire which is connected to the relay on the fusebox harness to operate a blower (Optional)



NOTE

For marine installations there are a number of wires in the main harness that are not required and should be insulated and tied back onto the harness.

These are:

- Grey
- Violet
- Black/Red
- Green/White

ELECTRICS (continued)

The Fusebox harness and main harness now have to be connected together. First crimp the special fuse box terminals shown below to the two red wires on the main harness.

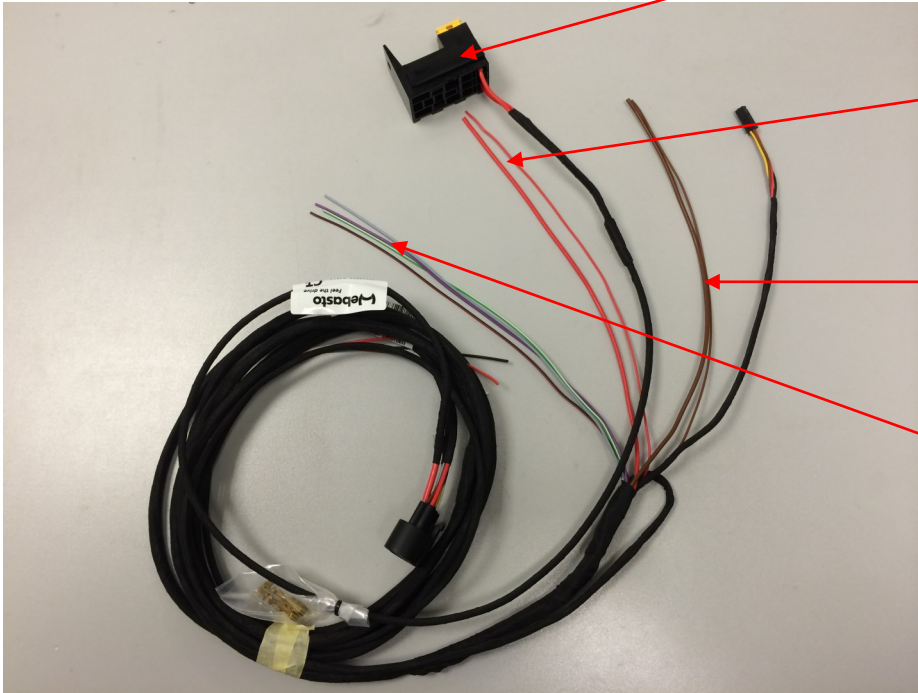

Fuse block on fusebox harness

2 Red wires on Main Harness to be inserted into fusebox using the terminals supplied.

2 Brown wires to connect to battery negative

Insulate and tie back as instructed previously.

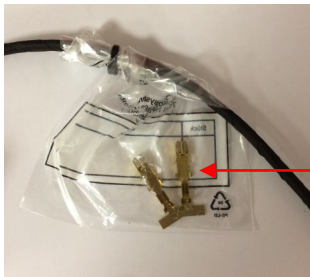

Terminals to crimp onto red wires on main harness and inserted into fuse block.

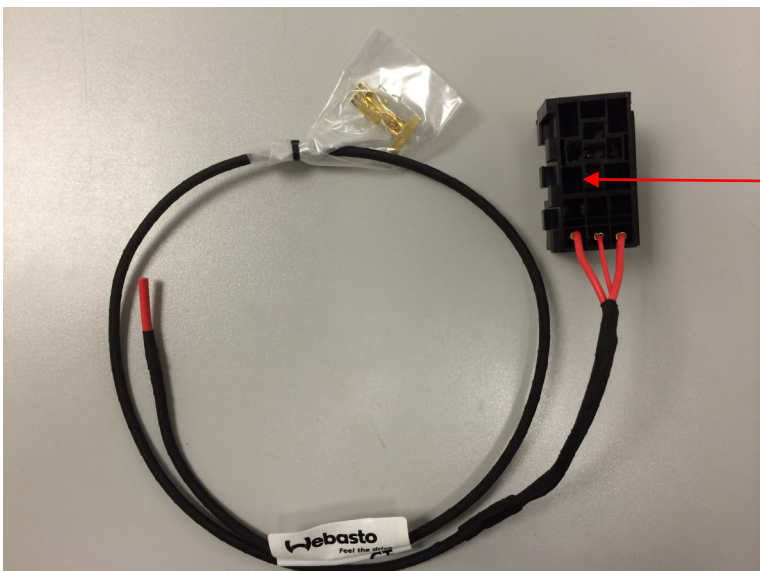

Insert red wires into corresponding holder marked CPU and CLOCK.

ELECTRICS

(Continued)



Feel the Drive

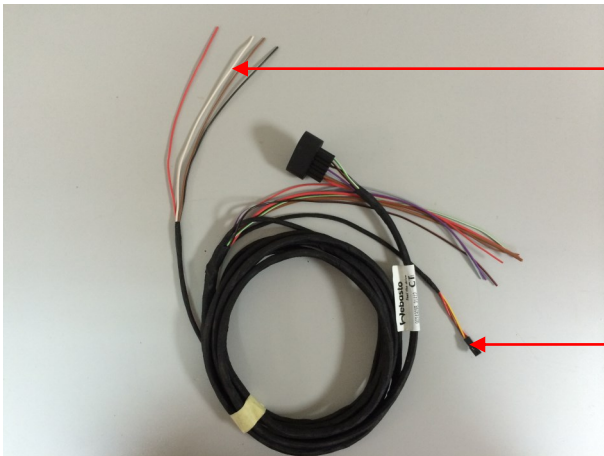

Red, White, Brown, Black wires on main harness connect to operation switch.

Diagnostic plug, ensure this is accessible for heater servicing.

Wiring of operational switch

- Red = A
- Black = B
- White = E
- Brown = F

A&B Are the two wires that switch the heater on/off.
E&F Are used to illuminate the light inside the switch which is used for operation indication and also as a fault code indicator. If a fault develops a number of flashes are made to indicate the nature of the fault.

Two Position Switch 109995 & 109999
Front & Back

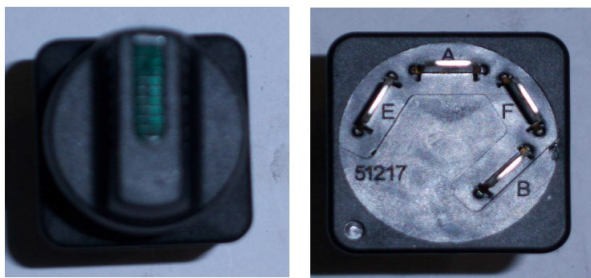

It can be seen from the information given above that it is very simple to use other types of switches to operate the heater. It is possible to use also timers and electronic programmers that use volt free contacts for heater operation.

If a wall thermostat is to be fitted, keep the existing on/off switch but wire in the thermostat in series with the Black wire that is connected to pin 'B' of the switch.

COMMISSIONING

Upon completion of the installation, check the integrity of all joints. Fill the heating system with 75/25 water/antifreeze mixture through the fill point. Bleed as much air as possible from the system and the radiators before commencing the start up procedure.

Pressurised Expansion Vessel

Installations

Pre fill the heating water system as detailed above but with 75% water / 25% antifreeze. With this system it may be necessary to fill the radiators with a filling tool or make up a pipe and inject the coolant through a radiator bleed vent.

Because this system needs to be pressurised the remainder of filling will need to be done with the filling loop. Open both ball valves on the filling loop and commence filling until the pressure gauge reads 1bar (14.5psi).

It will be necessary to fill the system up and bleed all the radiators and recharge again. This process will have to be repeated a number of times. Check all electrical connections. Turn the isolation switch to the 'ON' position.

Switch the heater on at the operating switch. The heater will commence it's start up procedure. Several start attempts may be required in order to bleed enough fuel through to the heater to enable start up.

Satisfactory operation will only be achieved once all air bubbles have cleared from the fuel lines.

Switch on the heater, make sure the pressure gauge does not drop below approximately 0.5 bar / 7psi.

After a few minutes of running vent the radiators again and recharge the system with the filling loop to 1bar / 14.5psi.

Be aware that the pressure may drop during this period due to the AAV's (Auto Air Vents) if fitted. When all the air is out of the system and the pressure is at 1bar / 14.5psi turn off both of the ball valves on the filling loop.

Switch off the heater and allow to cool. When cold, check the 'cold water pressure' and recharge to 1bar / 14.5psi if required. Turn off the ball valves on the filling loop.

If the system is over charged by mistake the excess pressure can be removed by either bleeding the radiators or turning the knob on the pressure relief valve.

Note when the system is operating the pressure will increase by approximately 25% of the cold pressure.

Fuel system

The fuel line will need to be primed in order for the heater to operate.

When the water circuit has been checked for the correct content of water switch on the heater.

The heater goes through a start up procedure where the water pump and air fan start, followed by the glow pin and fuel pump.

When the heater is switched to ON the heater will go through two automatic start attempts and then go into fault mode and blink a fault code.

Turn the heater off, wait 3 minutes and turn back ON. Again the heater will go through two start attempts.

If it fails to start again the heater will 'lock out'.

























To unlock, remove the fuses and wait 30 seconds, replace and switch back on.

Repeat as required until the fuel reaches the heater.

FAULT DIAGNOSIS

The heater will perform a diagnostic check of its components prior to commencement of the start up cycle. If a fault is present, the heater will perform a purge cycle, where the combustion air motor will run for 180 seconds and the green operation indicator light in the switch or 24 hour timer will flash a fault code. This will consist of 5 short flashes (indicating a fault) and a number of long flashes (indicating the nature of the fault). The following diagnostic chart and flow chart can be used as a guide to identify the failure.

BLINK CODE DIAGNOSTIC CHART

		CHECK FOR FAULTS									
		FUEL SYSTEM	FLAME DETECTOR	COMBUSTION AIR MOTOR	LOW VOLTAGE AT ECU	GLOW PIN	DOSING PUMP	TEMP SENSOR	OVERHEAT SWITCH	CONTROL UNIT	COMBUSTION AIR EXHAUST SYSTEM
BLINK CODE/FAULT											
1X	NO START										
2X	FLAME CUT OUT DURING COMBUSTION										
3X	LOW VOLTAGE										
4X	FLAME DETECTOR HOT										
5X	FLAME DETECTOR DEFECTIVE										
6X	TEMP SENSOR DEFECTIVE										
7X	DOSING PUMP/OVER HEAT OPEN CIRCUIT										
8X	COMBUSTION AIR MOTOR DEFECTIVE										
9X	GLOW PIN DEFECTIVE										

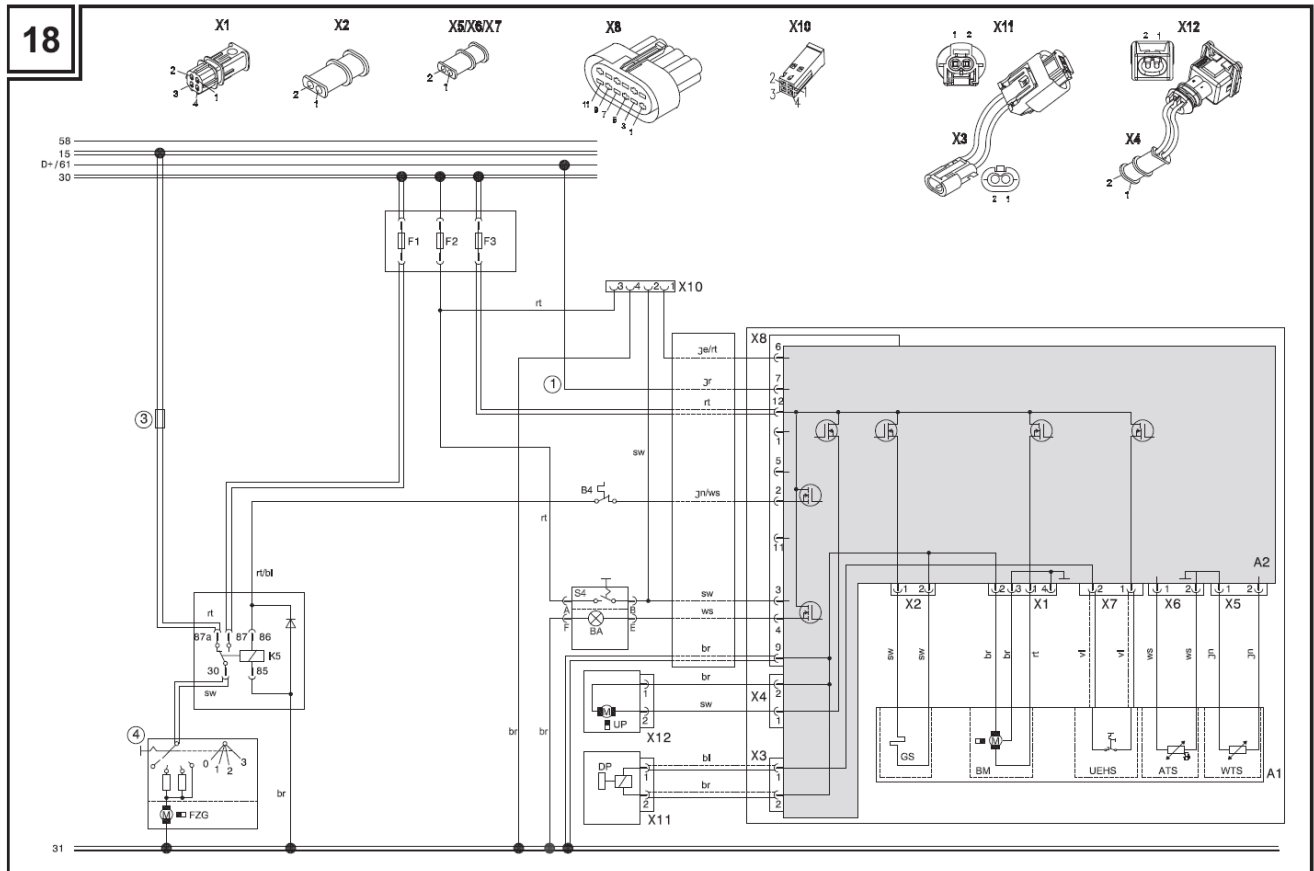

Item	Description	Comment
①	Temperature coding	D+ signal (vehicle engine ON/OFF) for determination of the control temperature
②	Standard clock P2	- with ignition (Terminal 15) on connection 10: Continuous operation with immediate heating and ignition on - Connection 10 open: Heating duration is programmable (10 to 120 min.), basic setting 120 min.
③	Vehicle fuse	for vehicle fan
④	Vehicle fan switch	
A1	Heater	Thermo Pro 90
A2	Control unit	
ATS	Exhaust temperature sensor	PT2000
B4	Room thermostat	optional
BA	Operation indicator	Light max. 2 W
BM	Burner motor	Combustion air fan
DP	Metering pump	Fuel pump for heater
F1	20 A fuse	Flat fuse SAE J 1284
F2	5 A fuse	Flat fuse SAE J 1284
F3	20 A fuse	Flat fuse SAE J 1284
FZG	Vehicle fan	
GS	Glow plug	
H1	"Heating" symbol in the display	Operating indicator (in item P2)
H3	Symbol light	Light (in item P2)
H5	Switch-on indicator pumping device	Light max. 1.2 W
H6	Lighting of immediate heat button, BA, switch-on check	Red LED (in Pos. P2)
K3	Relay	Circulation pump remote control

	Length < 7.5 m	Length 7.5 - 15 m	bl	blue
————	0.75 mm ²	1.0 mm ²	br	brown
- - - - -	1.0 mm ²	1.5 mm ²	ge	yellow
————	1.5 mm ²	2.5 mm ²	gn	green
————	2.5 mm ²	4.0 mm ²	gr	grey
————	4.0 mm ²	6.0 mm ²	or	orange
			rt	red
			sw	black
			vi	violet
			ws	white

Item	Description	Comment
K5	Vehicle fan relay	
P2	Standard clock	For programmed operation
S4	On/Off switch	with BA, in place of standard clock
S6	Emergency-Off switch, mechanical or pneumatic	Isolating switch
S7	Pumping device switch	ADR
S8	Immediate heating signal	Momentary-contact switch (optional via remote control)
S10	Electronic battery switch	
UH5	Overheating protection	Sensor on heat exchanger
UP	Circulation pump	
WTS	Coolant temperature sensor	Coolant temperature in coolant circuit
X1	Plug connector, 4-pin	Pos. BM to Pos. A2
X2	Plug connector, 2-pin	Pos. GS to Pos. A2
X3	Plug connector, 2-pin	Pos. DP to Pos. A2
X4	Plug connector, 2-pin	Pos. UP to Pos. A2
X5	Plug connector, 2-pin	Pos. WTS to Pos. A2
X6	Plug connector, 2-pin	Pos. ATS to Pos. A2
X7	Plug connector, 2-pin	Pos. UH5 to Pos. A2
X8	Plug connector, 12-pin	Wiring harness, vehicle-specific
X9	Plug connector, 12-pin	Pos. P2
X10	Plug connector, 2-pin	W bus PC diagnosis
X11	Plug connector, 2-pin	to Pos. DP
X12	Plug connector, 2-pin	to Pos. UP
Y2	Solenoid valve for pumping device	

Marine Water Heater Installation Checklist

Installation Check Points	Yes / No
1 Heater securely mounted at the correct angle	
2 Additional Product ID label affixed to opposite side of heater	
3 Fuel Dosing Pump securely mounted within anti vibration clip	
4 Fuel Dosing Pump mounted clear of external heat sources	
5 Fuel Dosing Pump mounted level	
6 Fuel Dosing Pump electrical connector angled downwards	
7 Fuel Dosing Pump is protected from mechanical damage	
8 Standpipe cut at the correct length	
9 Standpipe installed securely and leak free	
10 Fuel lines all flared	
11 Flared ends of fuel lines still 2mm ID after flaring	
12 Fuel lines fixed securely along their entirety	
13 Fuel lines are routed away from external heat sources	
14 Fuel lines are protected or routed so as to prevent accidental damage	
15 Fuel lines terminated with ISO7840 rubber hose sections	
16 ISO7840 rubber hose sections pushed fully onto heater inlet and fuel pump flared stubs	
17 Flared ends of copper pipes push fully into ISO7840 rubber hose sections	
18 Fuel lines fitted with hose clamps securely	
19 The heater is mounted no more than 3m above the fuel dosing pump	
20 Distance between fuel standpipe inlet tip to the dosing pump is not more than 1.2m	
21 Distance between the dosing pump is not more than 8.8m	
22 The fuel being used is either EN590 Diesel or BS2869A2 Gasoil.	
23 The fuel is visually free from contamination of water, solids.	
24 There exists an adequate supply of fuel in the tank	
25 Exhaust flexible pipe is securely fixed at both ends to prevent gas leakage	
26 Exhaust is lagged with thermal insulation	
27 Exhaust insulation is secured with stainless steel ties	
28 Exhaust is safely secured / routed to prevent damage to adjacent parts	
29 Exhaust has a 'swan neck' formed to prevent the ingress of sea water	
30 Exhaust skin fitting is mounted as high as possible above the waterline	
31 Exhaust emissions have been checked and adjusted using PC diagnostics tool	
32 Combustion air pipe has been installed on the correct port on the heater	
33 Combustion air pipe is not drawing air from inside the passenger compartment.	
34 Combustion air pipe is fitted so drive belt dust will not be sucked into heater	

Installation Check Points	Yes / No
35 Electrical plugs are securely and correctly installed	
36 The power supply requirements of the heater match those of the power supply used	
37 Power supply positive cable is connected direct to the battery isolator load side	
38 Power supply negative cable is connected to battery negative terminal, (shunt excepted)	
39 Power supply cables are securely connected	
40 The fuses are ok	
41 The fuses are correctly inserted into the carriers	
42 The fuses are the correct size	
43 The plug supplying the fuel pump is securely connected	
44 The electrical connections on all plugs, sockets and terminations are corrosion free	
45 The heater wiring harness is securely clipped to prevent heat or mechanical damage	
46 The connectors and terminations are not under any strain	
47 The battery is charged sufficiently to operate the heater	
48 The unused wires are safely tucked away or snipped off	
49 The water plumbing is based on a 22mm central spine	
50 The Calorifier if fitted is fitted with a balancing valve / lock shields	
51 The Calorifier has not been piped in series with the hot output	
52 The radiators are not fitted with Thermostatic Radiator Valves	
53 The flow & returns of the Calorifier and radiators are all balanced	
54 The air has being bled from the system completely	
55 The correct water / glycol mixture has been used	
56 The water / glycol was pre mixed before use	
57 The water system has been flushed out prior to being connected to the heater	
58 The water system is leak free	
59 When plumbed as a gravity fed system the header tank is filled to 'max'	
60 When plumbed as a pressurised system the cold pressure is 1 bar	
61 When plumbed as a pressurised system the 2 filling loop valves are OFF	
62 The designed heating load is correctly matched to the heater output	

