

Air Heater



Air Top 2000 ST B Air Heater



00 0022

Air Top 2000 ST D Air Heater



00 0022

Installation documentation

VW T5

Petrol and Diesel
from Model Year 2004
Left-hand drive vehicle



WARNING!

Hazard warning:

Incorrect installation or repair of Webasto heating systems may cause a fire or result in the emission of carbon monoxide, which can be fatal. Serious or fatal injuries can be caused as a result.



Specialist company training, technical documentation, specialised tools and equipment are required to install and repair Webasto heating and cooling systems. Only original Webasto parts must be used. For this, also see the catalog of air and water heater accessories from Webasto.

NEVER attempt to install or repair Webasto heating or cooling systems if you have not successfully completed the company training and thereby acquired the required technical skills, or if you do not have access to the required technical documentation, tools and equipment needed to carry out correct installation and repairs.

ALWAYS follow all Webasto installation and repair instructions and observe all warnings.

The initial startup is to be executed with the Webasto Thermo Test Diagnosis.

Webasto does not accept any liability for defects and damage that are attributable to installation by untrained staff.

Table of Contents

Validity	2	Optional hot air system	14
Foreword	2	Optional Recirculating Air	17
Special tools	2	Electrical system	18
Heater/Installation Kit	3	Combination timer option	18
General Instructions	3	External temperature sensor	18
Explanatory Notes on Document	4	Remote option (Telestart)	19
Preliminary Work	5	Shut-down on fault	24
Heater installation location	5	Fault code output:	24
Preparing installation location	6	Final Work	25
Preparing heater	6	Template for Fuel Standpipe	26
Installing heater	7	Template for Fuel sender	26
Combustion air	8	Operating Instructions for End Customer	27
Fuel	9		
Exhaust gas	13		

Validity

Manufacturer	Model	Type	EG-BE No./ABE
VW	Multivan / Transporter	T5	e1 * 2007 / 46 * 0130 * ...
VW	Multivan / Transporter	T5	L148

Vehicle models, equipment variants as well as national specifications, which are not listed in this installation documentation, have not been tested. However, installation according to this installation documentation may be possible.

The installation location of heater controls and the routing of the air ducting parts must be coordinated with the final customer prior to installation!

WARNING!

Original load-bearing components of the vehicle and/or component used for crash safety may not be modified for the hot air and recirculating air ducting!



Foreword

This installation documentation applies to the vehicles VW T5 Petrol and Diesel (van with partition) - for validity, see page 2 - from model year 2004 and later, assuming technical modifications to the vehicle do not affect installation, any liability claims excluded. Depending on the version and the equipment of the vehicle, changes may be necessary relative to this "installation documentation" during installation and must be adjusted accordingly.

However, the stipulations in this "installation documentation" and "operating instructions" and the "maintenance instructions" for the *Air Top 2000 ST* must always be observed.

The corresponding rules of technology and any information from the vehicle manufacturer should be observed during the installation work.

Special tools

- Torque wrench for 2.0 - 10 Nm
- Metric thread-setter kit
- Blind rivet tool

Heater/Installation Kit

Quantity	Description	Order No.:
1	Basic Delivery Scope <i>Air Top 2000 ST</i> Petrol	See price list
or		
1	Basic Delivery Scope <i>Air Top 2000 ST</i> Diesel	See price list
and		
1	Standard installation kit <i>Air Top 2000 ST</i>	See price list
1	Standard installation kit <i>Air Top 2000 ST</i> VW T5 Gasoline and Diesel	9014156A
1	Heater control	See price list

The installation kit contains the bracket with fastening parts.
The required air ducting parts must be ordered as an option from the Webasto Accessories Catalog in accordance with the customer order!



To be ordered as an option for vehicles without factory-installed parking heater:

Quantity	Description	Order No.:
1	Fuel standpipe	1300823B

To be ordered as an option for vehicles with factory-installed parking heater:

Quantity	Description	Order No.:
1	6x5x6 mm fuel standpipe	66944A

To be ordered as an option when using fresh-air mode:

Quantity	Description	Order No.:
1	External temperature sensor	9005004B

The materials used for this application example - in accordance with validity on page 2 - are contained in the following list. In case of deviations in accordance with the customer order, the materials actually required can be ordered from the currently valid Webasto Accessories Catalog.



Quantity	Description	Order No.:
1	Flexible tube PAK, inside dia.= 60 mm (cut to length)	398497
1	Flexible tube PAK, inside dia.= 55 mm (cut to length)	441376
5	Clamp, 50-70 mm dia.	139645
1	Air outlet, D1a = 60 mm; D2a = 92 mm; L = 65 mm	87389A
1	Air outlet, D1a = 55 mm; D2a = 87 mm; 45°	107836
1	Distributor with butterfly valve, outside dia. = 55 mm; L = 95 mm	101374
1	Reducing piece, D1a = 60 mm; D2a = 55 mm; L = 35 mm	29852A

General Instructions

Installation should be carried out according to the general, standard rules of technology. Unless specified otherwise, fasten hoses, lines and wiring harnesses to original vehicle lines and wiring harnesses using cable ties.

Sharp edges should be fitted with edge protectors (split-open plastic hose).

Spray unfinished body areas, e.g. drilled holes, with anti-corrosion wax (Tectyl 100K, Order No. 111329)

Explanatory Notes on Document

To provide you with a quick overview of the individual working steps, you will find an identification mark on the outside top right corner of the page in question.

Mechanical system

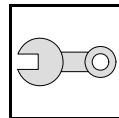

Electrical system

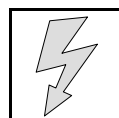

Heating air

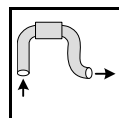

Fuel

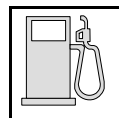

Exhaust gas

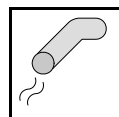

Combustion air

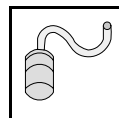

Special features are highlighted using the following symbols:



Specific risk of injury or fatal accidents.



Specific risk of damage to components.



Specific risk of fire or explosion.



Reference to general installation instructions of Webasto components or to the manufacturer's vehicle-specific documents.



Reference to a special technical feature.

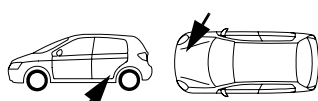

The arrow in the vehicle icon indicates the position on the vehicle and the viewing angle.

All dimensions are in mm!

Tightening torque of hose clamps = 2.0 + 0.5 Nm!

Preliminary Work

WARNING!

- Open the fuel tank cap, ventilate the tank.
- Close the tank cap again.
- Disconnect the battery "earth" or "ground" connection.
- Depressurize the cooling system.
- Copy the factory number from the original type label to the duplicate type label.
- Remove years that do not apply from the duplicate label.
- Attach the duplicate label (type label) in the appropriate place.
- Remove the underbody protection on the right and left (if present).
- Remove the fuel tank (only on vehicles without installed auxiliary or parking heater).
- Remove the fuel-tank sending unit in accordance with the manufacturer's instructions (only on vehicles without installed auxiliary or parking heater).
- Remove the trim on the front passenger side entrance (only with recirculating air mode).
- Remove the lower instrument panel trim on the driver's side.

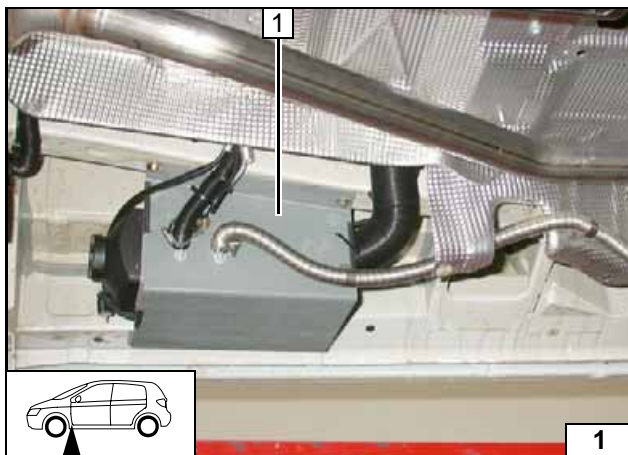

Heater installation location

1 Heater

Installation location

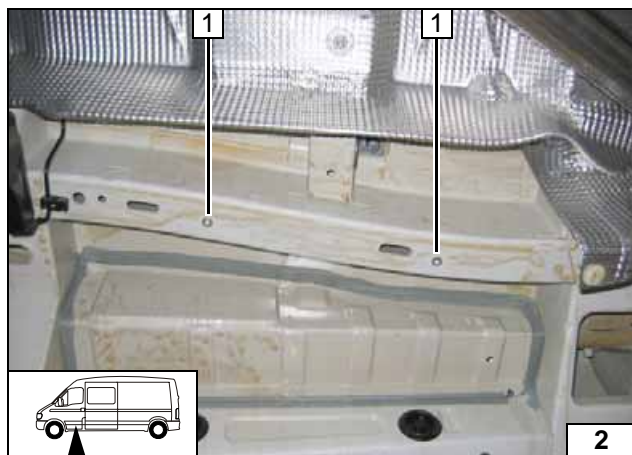
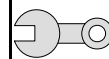

Preparing installation location

- 1 Rivet nut (2x), existing holes

Installing rivet nuts

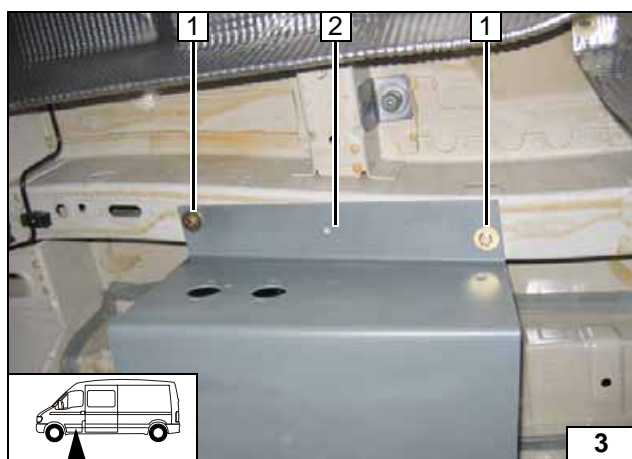

- 1 M6x20 bolt, large diameter washer [2x each]
- 2 Bracket

Installing bracket loosely

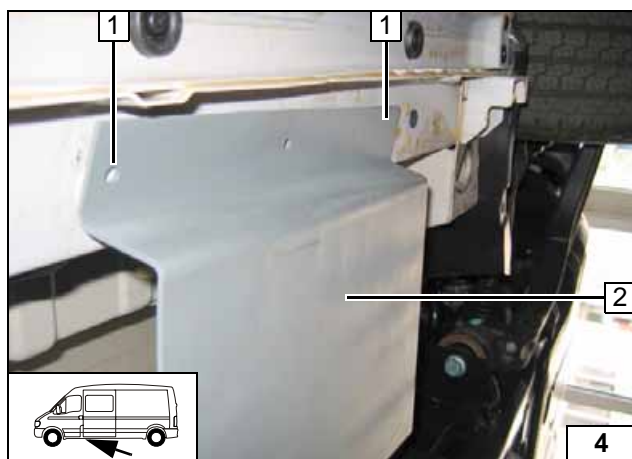

Copy hole pattern [2x] on position 1 to door sill. Remove bracket 2. Hole, 9.1 mm dia., [2x] on position 1, insert rivet nuts [2x]!



Copying hole pattern

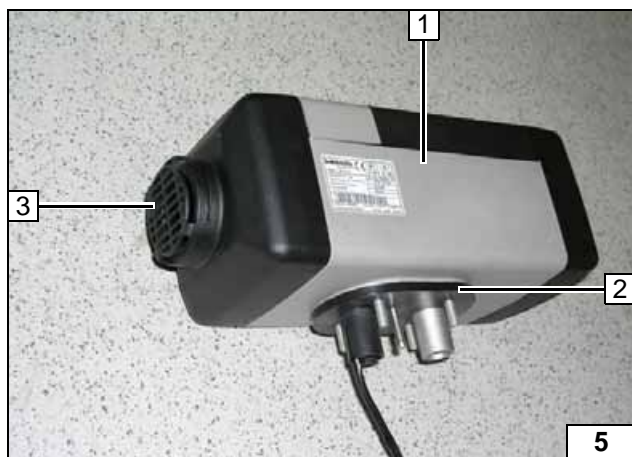

Preparing heater

With fresh-air mode, an underride protection as shown in Figure 33 must be installed if not present!

- 1 Heater
- 2 Mount base seal
- 3 Protective grill



Preparing heater

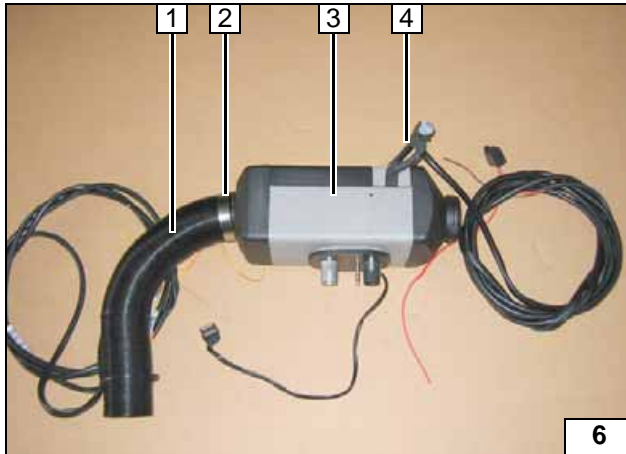
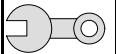

Cut approx. 360 mm from 60 mm dia. flexible tube 1 and fasten on heater.

- 2 50-70 mm dia. hose clamp
- 3 Heater
- 4 Wiring harness



Premounting heater

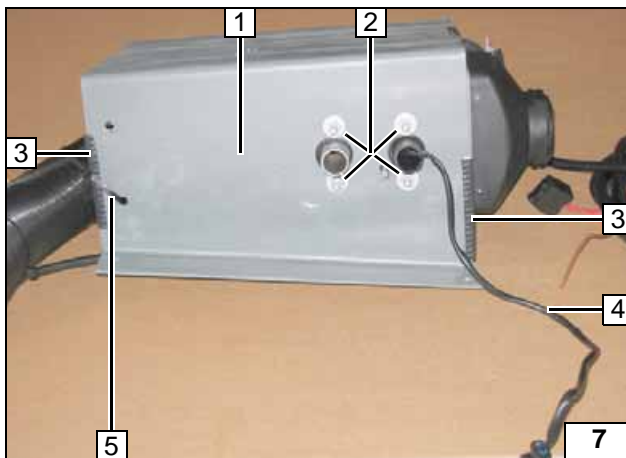

Route through wire of metering pump 4 downward. Fasten hot-air flexible tube on bracket with cable tie.

- 1 Bracket
- 2 Large diameter washer, spring lockwasher, M6 nut [4x each]
- 3 70 mm edge protection [2x]
- 5 Cable tie



Installing bracket

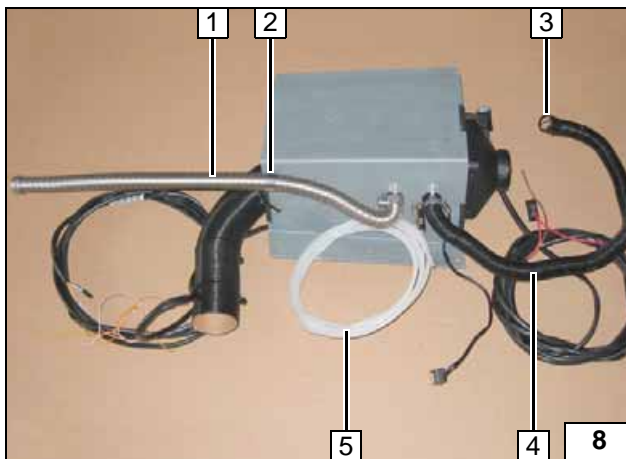

- 1 Exhaust pipe, hose clamp
- 2 P-clamp, 10 mm spacer sleeve, M6x20 bolt, flanged nut
- 4 Combustion air pipe, 27 mm dia. hose clamp
- 3 Protective cap
- 5 Fuel line, hose section, 10 mm dia. hose clamp [2x]

Installing lines

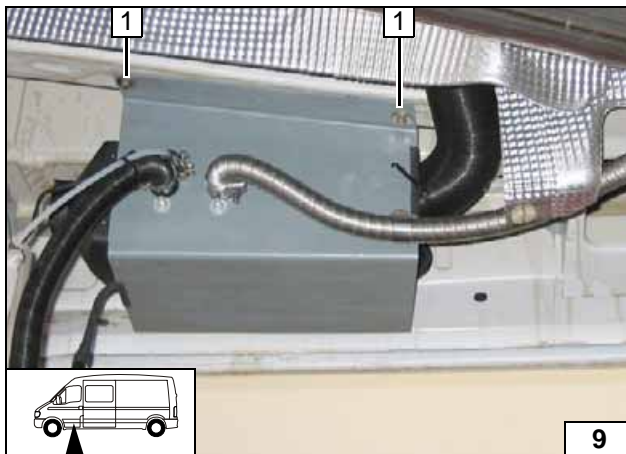

Installing heater

- 1 M6x20 bolt, spring lockwasher, large diameter washer [2x each]

Installing heater



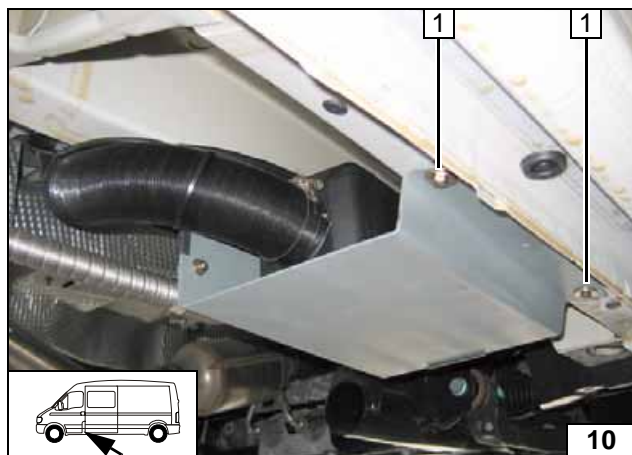
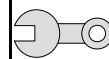

1 M6x20 bolt, spring lockwasher, large diameter washer [2x each]

Installing heater

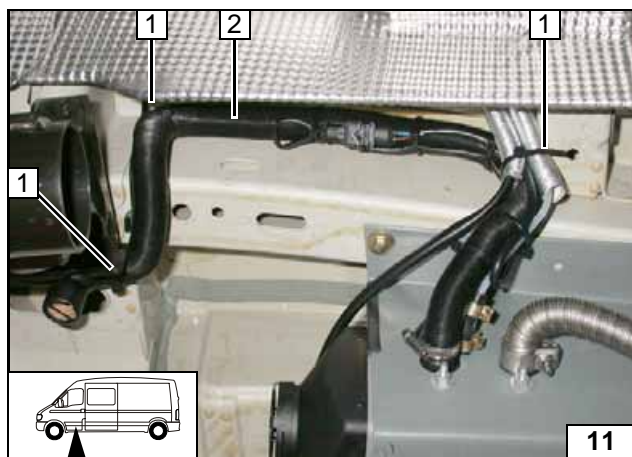

Combustion air

Shape combustion air line 2 and fasten with cable tie 1.



Installing combustion air pipe



Fuel

CAUTION!

Open the vehicle's fuel tank cap, ventilate the tank and then re-close the tank lock.

Catch any fuel running off with an appropriate container.

Install fuel line and metering-pump wiring harness so that they are protected against stone impact. Unless specified otherwise, always fasten using cable ties.

Mount the fuel line and wiring harness with rub protection on sharp edges.

WARNING!

The fuel line and wiring harness are routed to the metering pump in as shown in the wiring harness routing diagram.

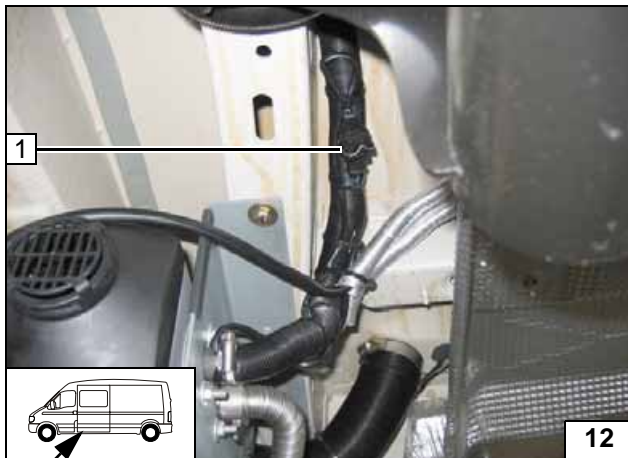

Complete connector with single wire seal [2x], tab connector and connector housing on wire of metering pump from heater and connect to wiring harness of metering pump.

1 Plug connection on wiring harness of metering pump

**Connect-
ing wiring
harness of
metering
pump**

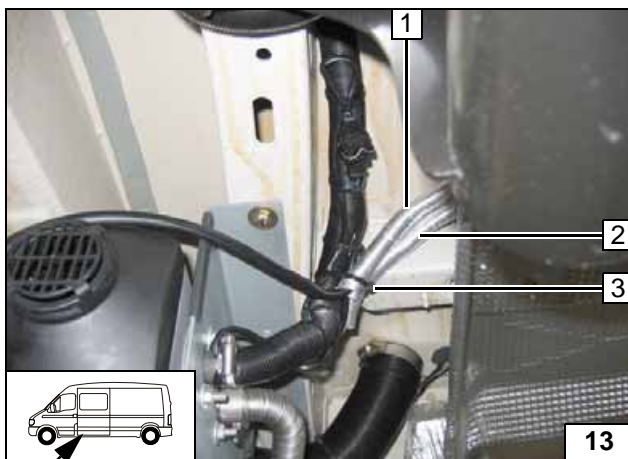

Divide heat protection hose. Pull wiring harness of power supply 1 and wiring harness of metering pump and fuel line 2 into one heat protection hose each.

3 Cable tie



**Installing
lines**

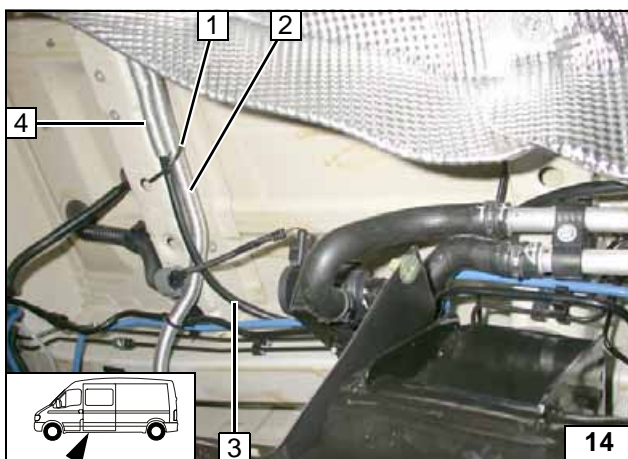

Install wiring harnesses of power supply 4, metering pump and fuel line 2 on the left side of the vehicle. Route wiring harness of power supply 3 further to battery.

1 Cable tie



**Installing
lines**

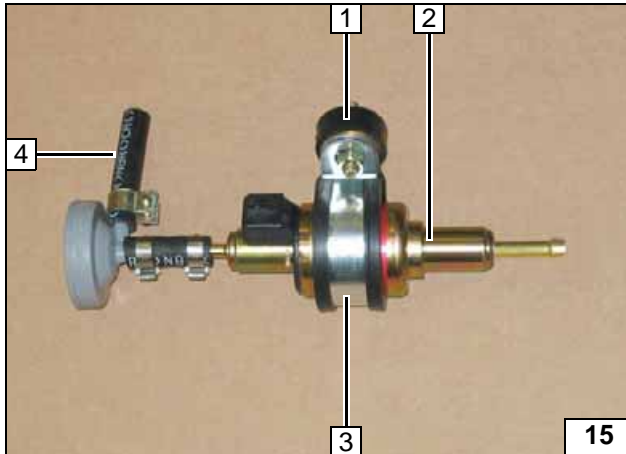

- 1 Silentblock, flanged nut
- 2 Metering pump
- 3 Rubber-coated pipe clamp
- 4 Hose section, 10 mm dia. clamp

Premounting metering pump

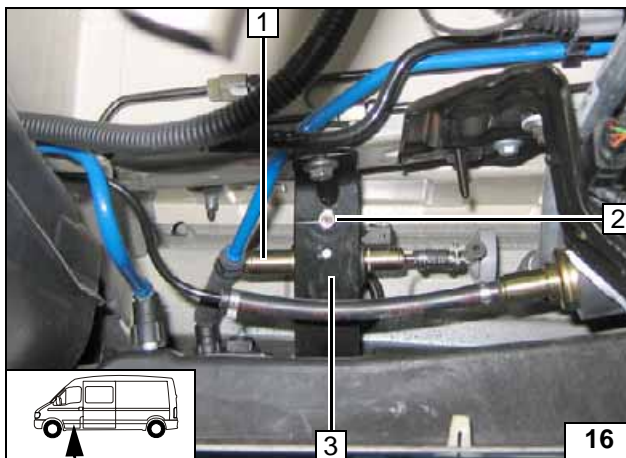

- 1 Preassembled metering pump
- 2 Flange nut, existing hole
- 3 Original vehicle strut



Installation location of metering pump

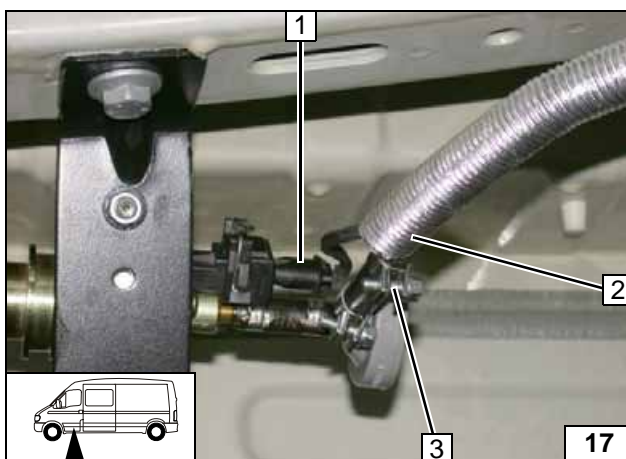

- 1 Wiring harness of metering pump, connector mounted
- 2 Fuel line from heater, 10 mm dia. clamp

Connecting metering pump

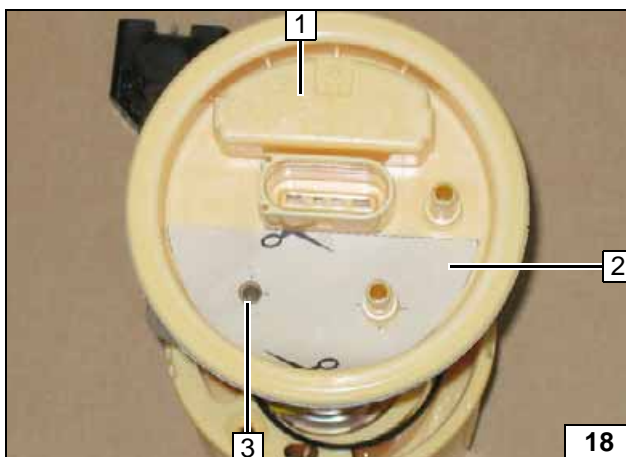

Without parking heater

Remove fuel-tank sending unit 1 in accordance with manufacturer's specifications. Cut out template 2 and attach.

- 3 Copy hole pattern, 6 mm dia. hole



Removing fuel

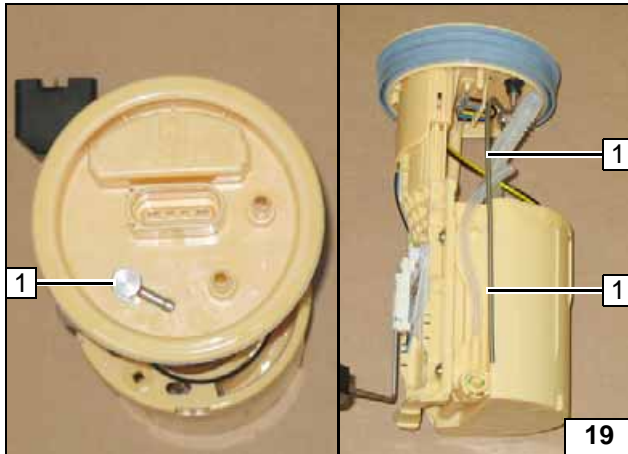

Shape fuel standpipe 1 according to template, cut to length and install.



Installing fuel standpipe

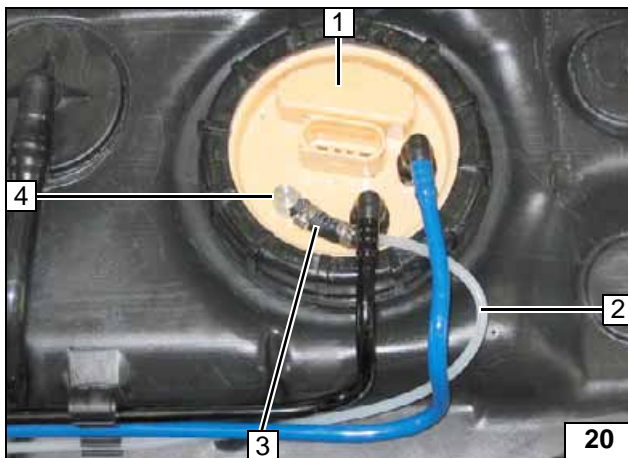

Install fuel-tank sending unit 1 in accordance with manufacturer's specifications.



- 2 Fuel line
- 3 Hose section, 10 mm dia. Caillau clamp [2x]
- 4 Fuel standpipe

Connecting fuel line



Install fuel line from fuel standpipe 2 into existing fastening points 1 [3x]. Remount fuel tank.

Install fuel line

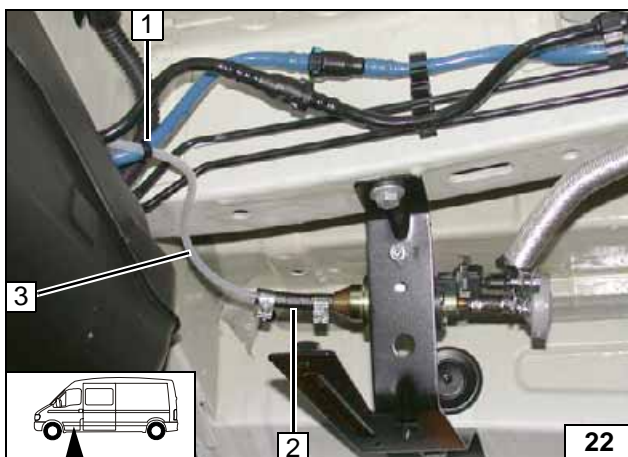

Check the position of the components; adjust if necessary. Check that they have free clearance.



- 1 Cable tie
- 2 Hose section, 10 mm dia. clamp [2x]
- 3 Fuel line
- 4 Original vehicle bolt

Connecting metering pump

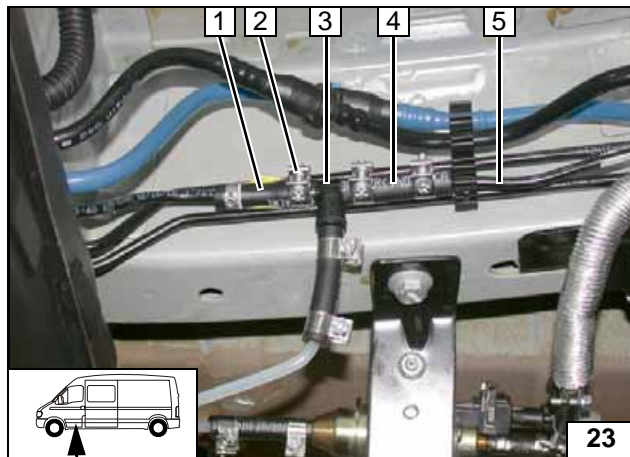
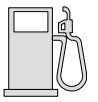

With parking heater

Disconnect fuel line to the parking heater **5** on original connecting point **1**. Remove single lug clamp on position **2**. Install 6x5x6 fuel standpipe **3** in cutting point.

- 2** 10 mm dia. clamp
- 4** Hose section, 10 mm dia. clamp [2x]



Removing fuel

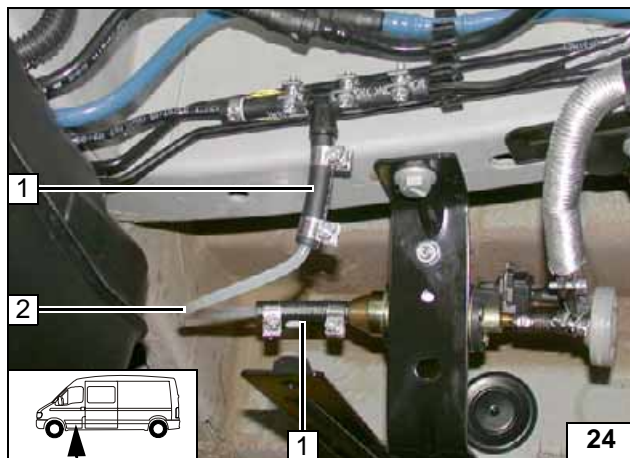

Check the position of the components; adjust if necessary. Check that they have free clearance.

- 1** Hose section [2x], 10 mm dia. clamp [4x]
- 2** Fuel line



**Connect-
ing meter-
ing pump**

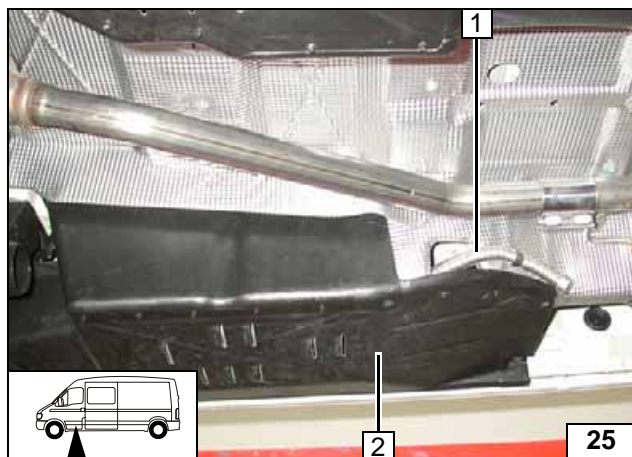
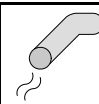

Exhaust gas

Vehicle with underride protection

The installation of the exhaust silencer as shown is not available in a vehicle equipped with underride protection.

- 1 Exhaust pipe
- 2 Underride protection

Exhaust si-
lencer

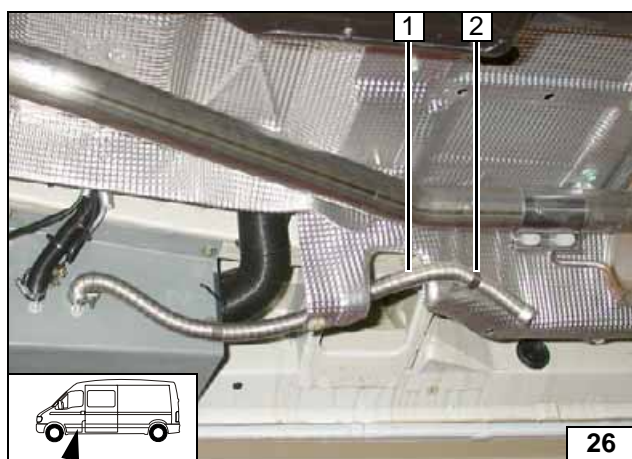

Vehicle without underride protection

Align exhaust pipe 1 as shown.
Drill 2 mm dia. condensed-water drain hole at lowest point in exhaust pipe 1 .
Ensure sufficient distance to neighboring components.

- 2 Self-tapping screw, p-clamp, 10 mm spacer sleeve

Fastening
exhaust
pipe

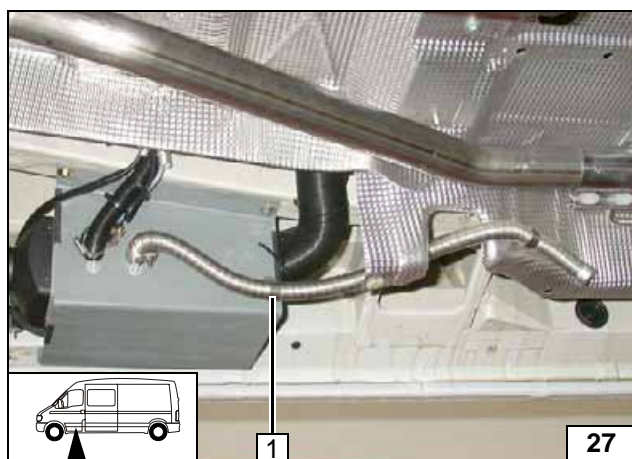

Remove p-clamp 1.

Removing
p-clamp

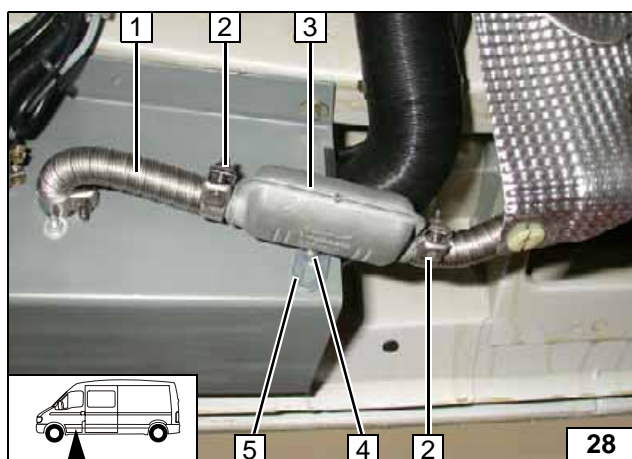

Disconnect exhaust pipe 1 and install silencer 3.

- 2 Hose clamp [2x]
- 4 M6x20 bolt, flanged nut
- 5 Angle bracket, M6x20 bolt, flanged nut

Installing
silencer



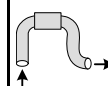

Optional hot air system

WARNING!

The routing of the air ducting parts shown is an application example on the van with a partition wall. Should other versions and equipment variants be used, then the appropriate adjustments must be made.

Before installation, the routing of the air ducting parts must be coordinated with the end customer!

Install flexible tubes so that they are kink-free. Unless specified otherwise, always fasten using brackets and cable ties.

The hot air ducting on this version example is executed as shown in the following diagram:

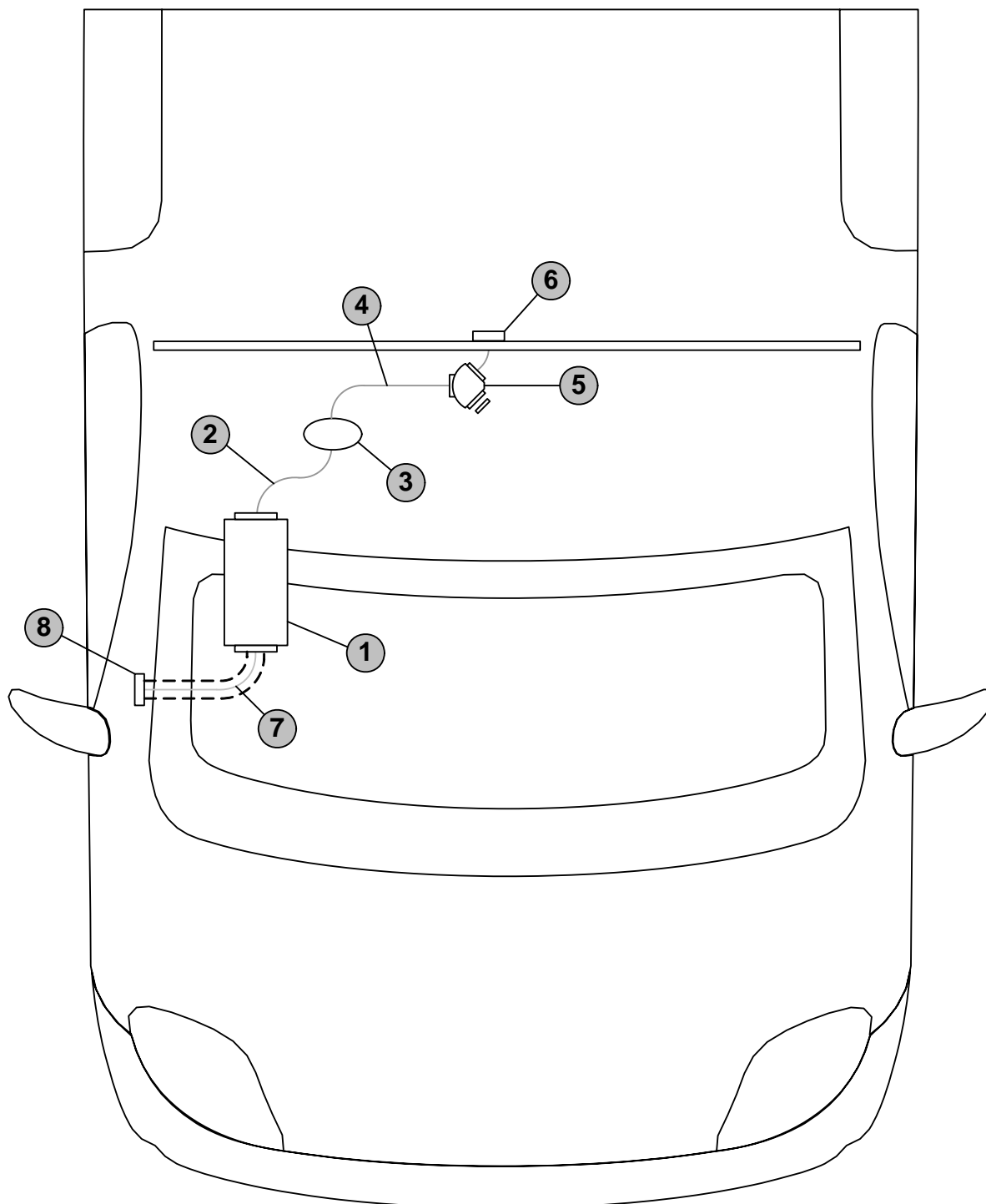

- | | | | |
|-------------------------------|------------------------------|---------------------|-------------------------------|
| 1 = Heater | 3 = Adapter 55x60 mm dia. | 5 = Air distributor | 7 = Flexible tube, 60 mm dia. |
| 2 = Flexible tube, 60 mm dia. | 4 = Flexible tube, 55mm dia. | 6 = Air outlet | 8 = Air grille |

Diagram
for hot air
ducting



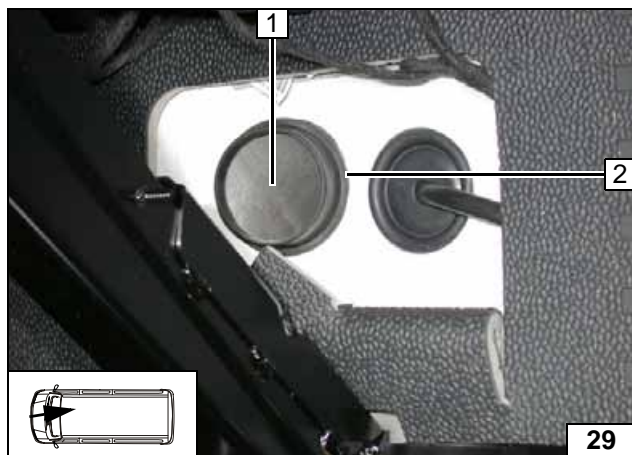
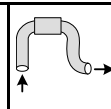

Fold back cover under front passenger seat. Apply 55x60 mm dia. adapter 2 and transfer hole pattern 1.



Hole under front passenger seat

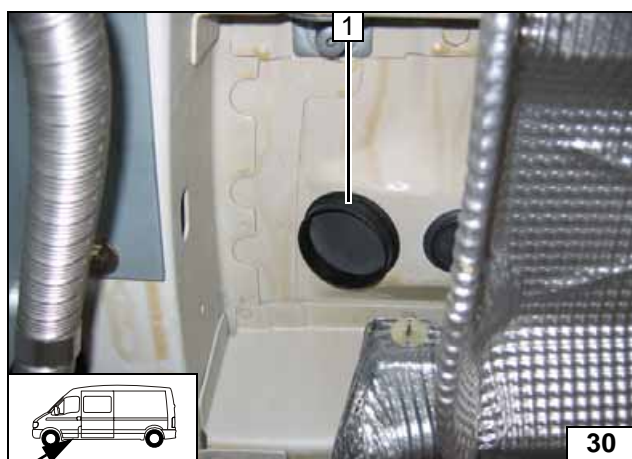

Mount adapter in hole from above and glue in with Sicaflex.



Gluing in adapter

1 55x60 mm dia. adapter

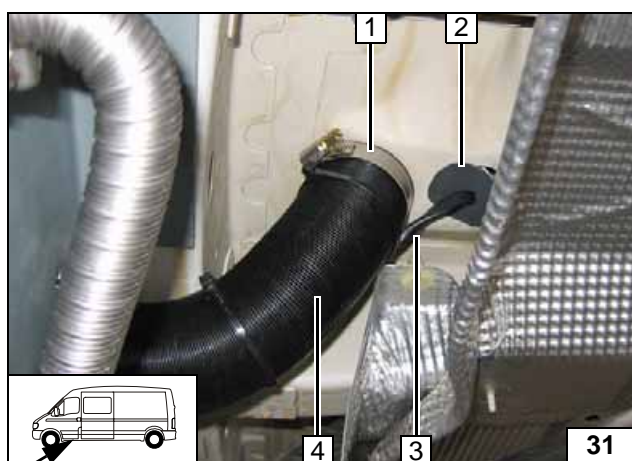

Mount 60 mm dia. 360 mm long flexible tube 4 on adapter. Route wiring harness of controls 3 through protective rubber plug 2 into passenger compartment.



Pass throughs into passenger compartment

1 50-70 mm dia. hose clamp

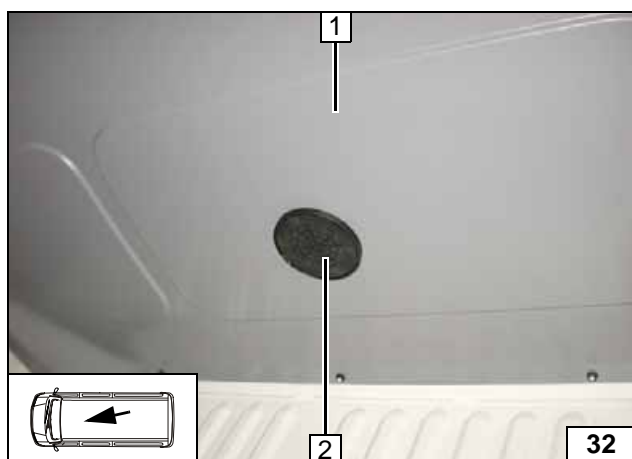

55 mm dia. hole at position 2 in partition wall 1. Install air grille 2 and fasten with blind rivets!



Hole in partition wall

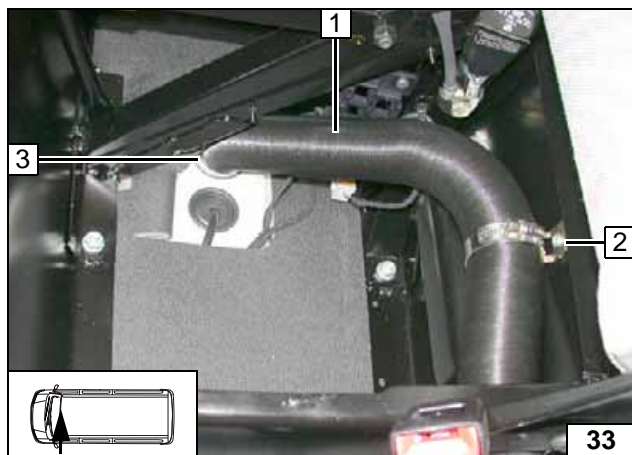
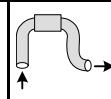

Cut 55 mm dia. flexible tube **1** as shown and connect to adapter on position **3**!

- 2** Bracket with hose clamp, self-tapping screw [2x]
- 3** 50-70 mm dia. hose clamp



Routing under front passenger seat

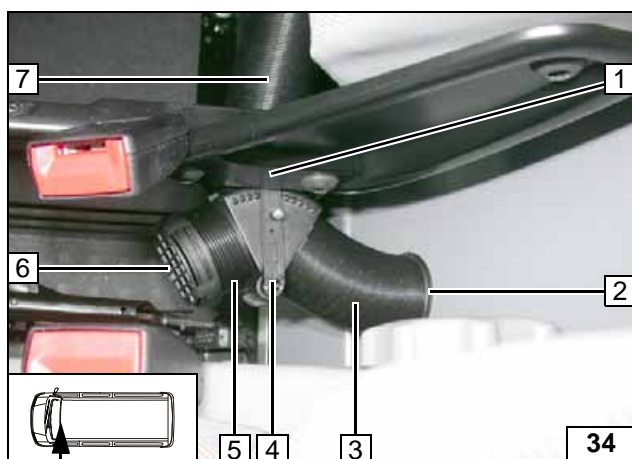

55 mm dia. hole in pass-through on position **1**. Cut 55 mm dia. flexible tube **3** and **5** to length as shown. Install air distributor **4**! Air outlet must be aligned so that hot air is not directed at controls (e.g. handbrake lever)!

- 2** Air outlet
- 3** 55 mm dia. flexible tube to air outlet
- 5** 55 mm dia. flexible tube
- 6** End cap
- 7** 55 mm dia. flexible tube from adapter



Mounting distributor

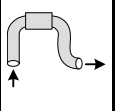

Optional Recirculating Air

No underride protection 1 is required for the option recirculating air mode!



Underride protection

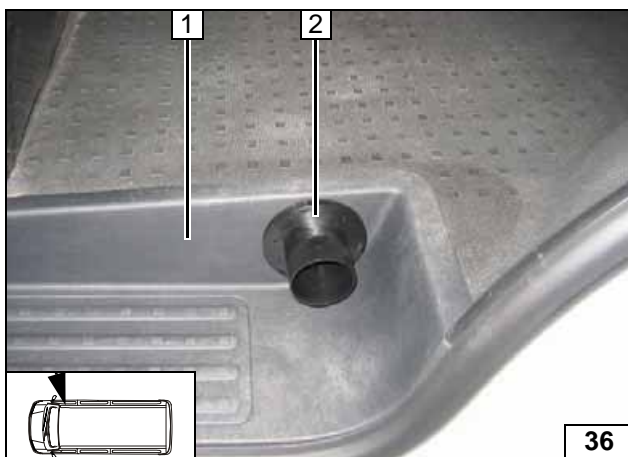

Lay air outlet 2 on entrance trim on front passenger side 1 as shown; copy inside dia. and hole pattern for fastening [3x] to trim. Remove air outlet 2 and 60 mm dia hole in trim and passenger side entrance trim.



Installing air outlet

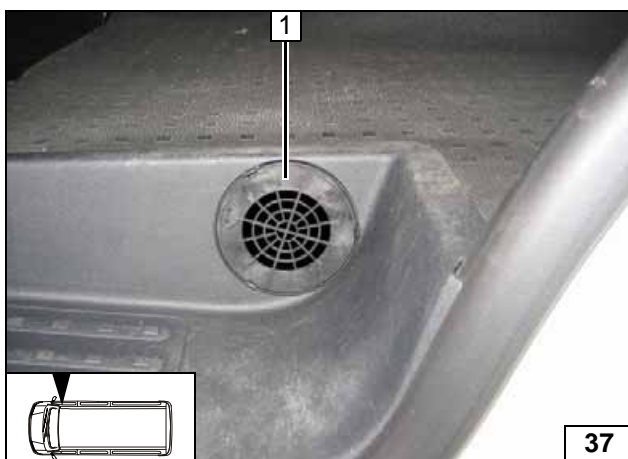

Hole for fastening air outlet [3x] in trim. Install air grille 1 in trim and fasten with blind rivets.



Installing air outlet

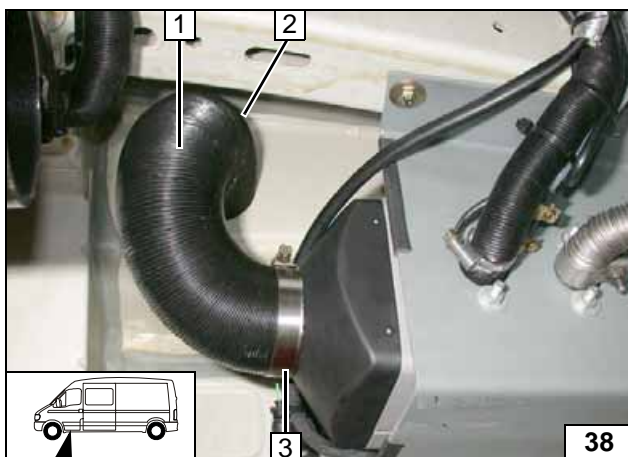

Remove protective grill at position 3. Cut 60 mm dia. flexible tube 1 to length as shown and connect to air outlet 3. Following installation, seal off pass through at position 2 with Sicaflex.



Installing intake hose

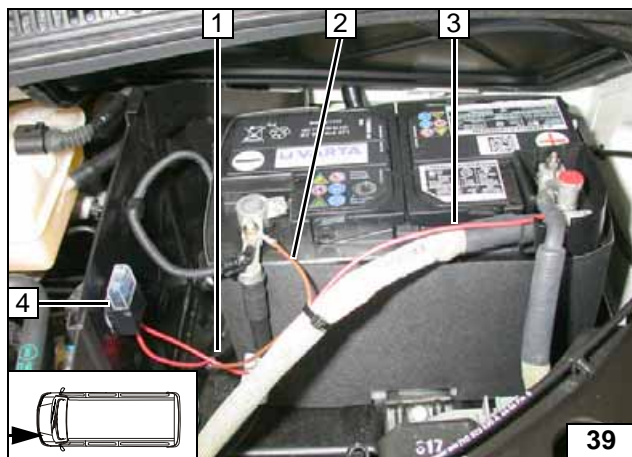

Electrical system

- 1 Wiring harness of power supply for heater
- 2 Earth wire on negative battery terminal
- 3 Positive wire on positive battery terminal
- 4 Fuse holder retaining plate, M4x12 bolt, washer, M4 nut

Install fuse holder



- 1 Thermostat



Installing heater control

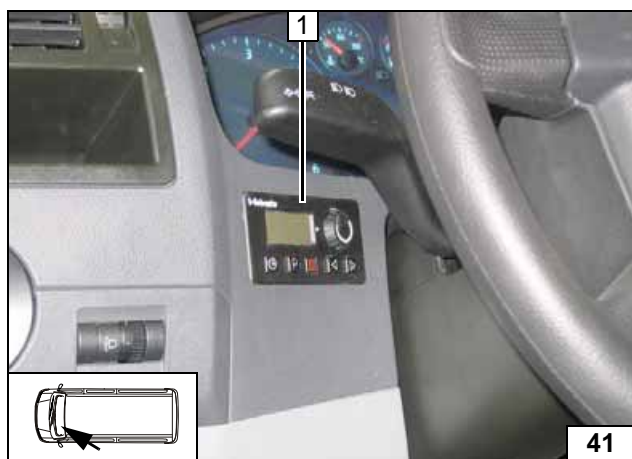

Combination timer option

- 1 Combination timer



Installing combination timer

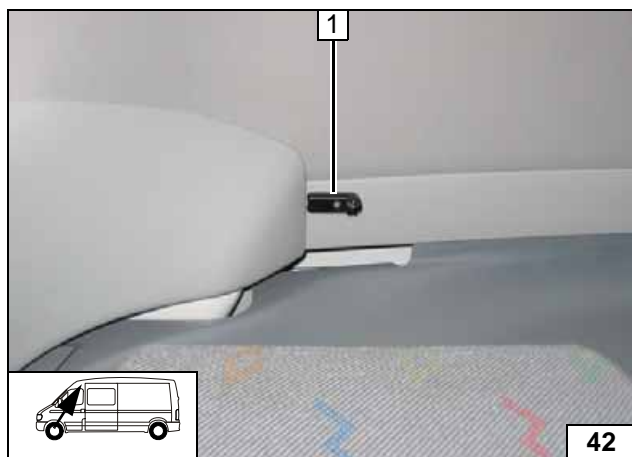

External temperature sensor

Installation is not carried out in recirculating air mode!

- 1 External temperature sensor



Installing temperature sensor

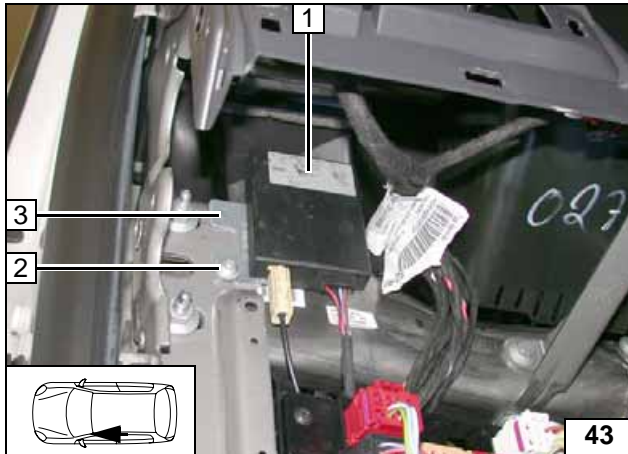

Remote option (Telestart)

Drill out bracket 3 to 6.5 mm dia. at position 2.

- 1 Receiver
- 2 Original vehicle bolt



Installing receiver

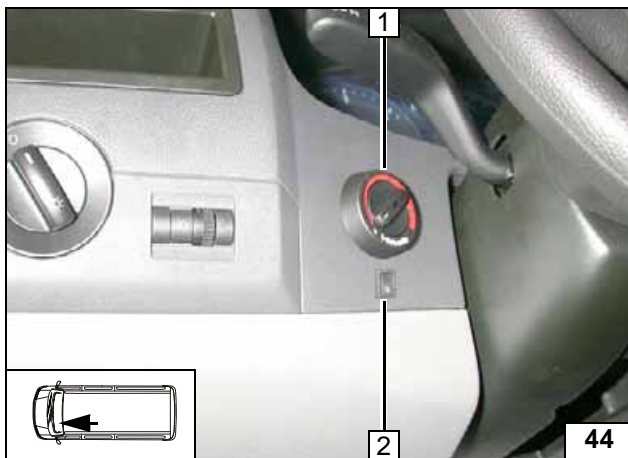

Only applies for combination of standard heater control with Telestart!

- 1 Standard heater control
- 2 Switch



Installing switch

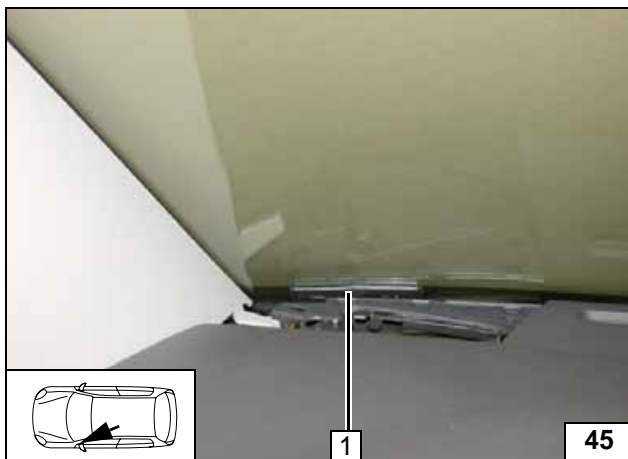

- 1 Antenna

Installing antenna

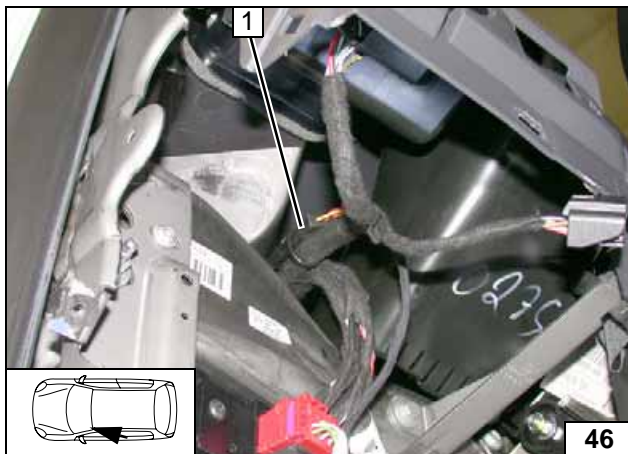

Temperature sensor HTM100

Fasten temperature sensor 1 with cable tie on original vehicle wiring harness.



Installing temperature sensor



System wiring diagram with heater control and vehicle fan

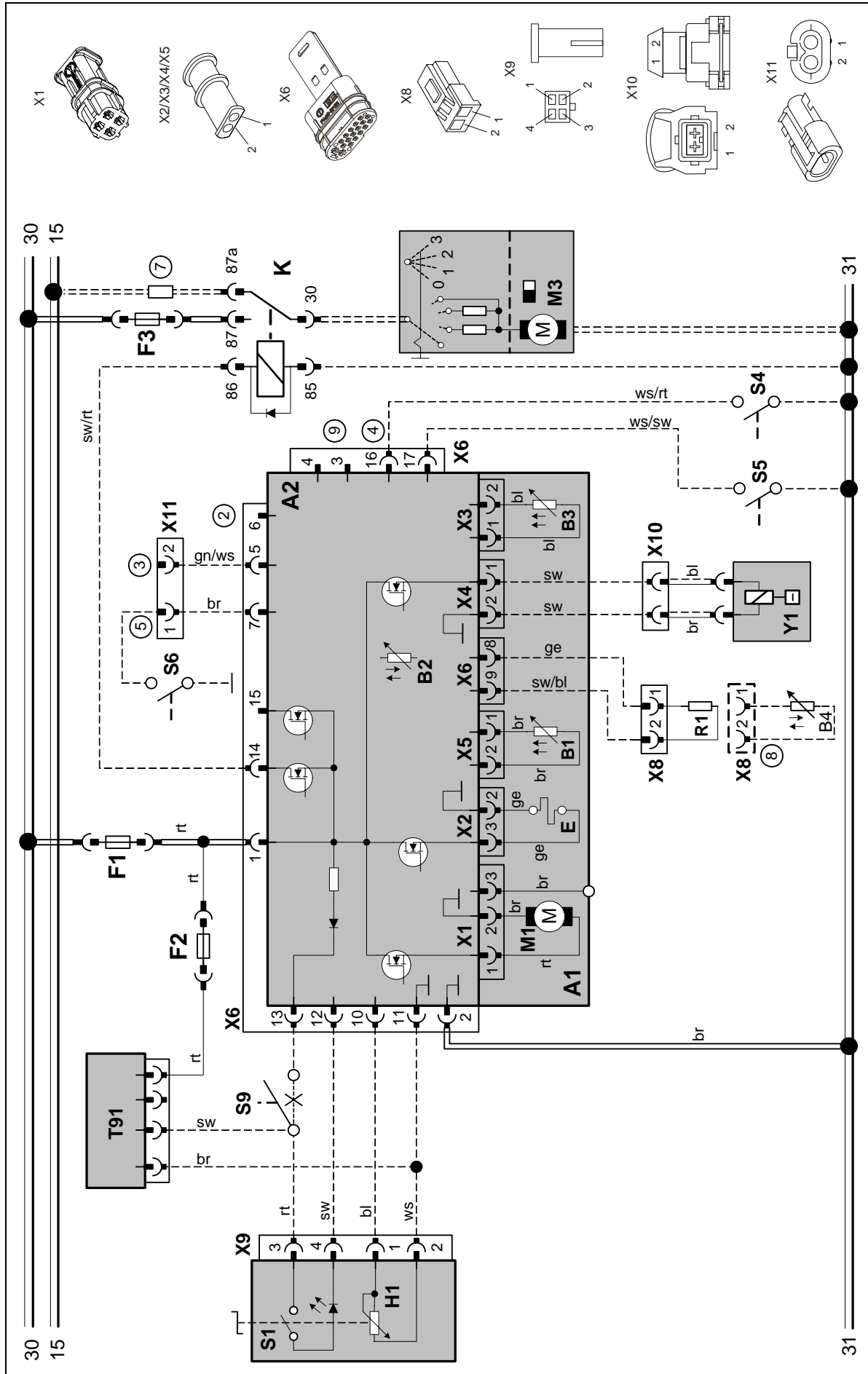

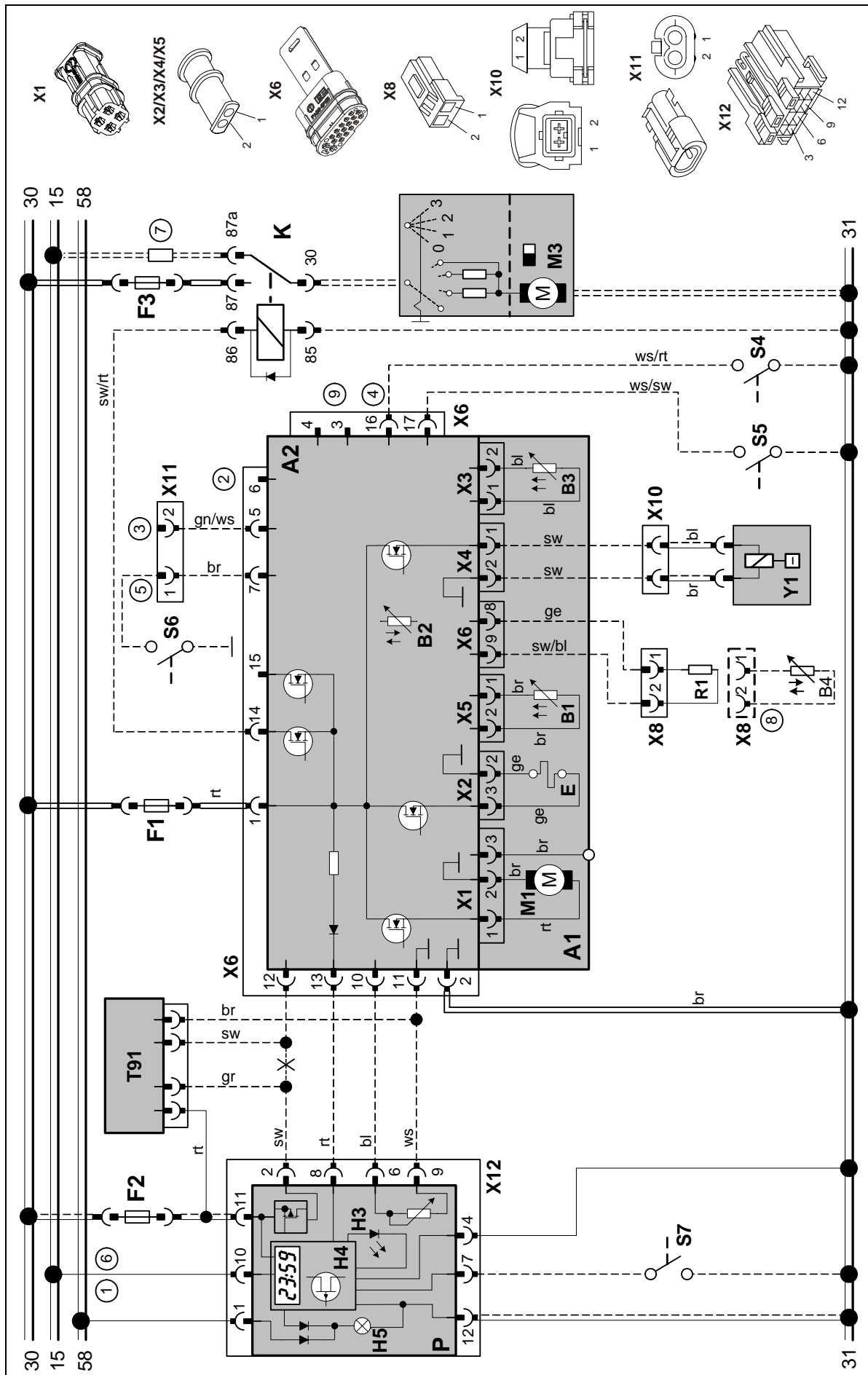

System wiring diagram with combination timer, Telestart and vehicle fan



①	With positive wire from terminal (15/75) to connection 10: Continuous operation with immediate heating as long as ignition is switched on Without positive wire on connection 10: Heating time is variably programmable (10 min. to 120 min.), default setting is 120 min.
②	K-wire diagnosis
③	W bus
④	Input pin (Pin 16/Connector X6, wire colour on wiring harness: white/red (ws/rt)): "Ventilate" (fan speed is dependent on position of heater control)
⑤	CO ₂ setting (see workshop manual)
⑥	NOTE: If a connection is made to Terminal 30, continuous heating operation is possible with ignition switched off. In this case, no connection may be made to Terminal 15/75!
⑦	Fuse present in vehicle
⑧	If an external temperature sensor (B4) is used, then the resistor R1 is replaced with the temperature sensor (B4)
⑨	Connection only for ADR vehicles
⑩	NOTE: Gray (gr) and violet (vi) wires required for ADR function
⑪	Stop signal for battery isolator switch. The stop input (if present) of the isolator switch (S2) must be connected to the control unit, Pin 15/Connector X6

Legend for
Wiring Dia-
grams

Wiring Colours	
rt	red
gr	gray
sw	black
br	brown
gn	green
bl	blue
ge	yellow
or	orange
vi	violet
ws	white

Wiring Cross-Sections		
	< 7.5 m	7.5 - 15 m
- - - - -	0.5 mm ²	0.75 mm ²
=====	0.75 mm ²	1.0 mm ²
== - - - - -	1.0 mm ²	1.5 mm ²
=====	1.5 mm ²	2.5 mm ²
=====	2.5 mm ²	4.0 mm ²
=====	4.0 mm ²	6.0 mm ²

Legend for
Wiring Dia-
grams



Pos.	Name	Remarks
A1	Heater	Air Top 2000 ST
A2	Control unit	
B1	Flame detector	Only on petrol unit
B2	Temperature sensor	Internal
B3	Overheating sensor	Overheating protection
B4	Temperature sensor	External
E	Glow element	
F1	24 V 15 A/12 V 20 A fuse	Blade fuse, SAE J 1284
F2	3A fuse	Blade fuse, SAE J 1284
F3	25 A fuse	Blade fuse, SAE J 1284
H1	LED, green (in Pos. S1)	Operation indicator
H3	LED, red (in Pos. P)	Lighting for immediate heating button, ready display, switch-on check
H4	Heating symbol in display (in Pos. P)	Operation indicator
H5	Lamps (in Pos. P)	Display and button lighting
H6	Lamp (at least 1.2 W)	Switch-on check for feed device
K	Relay with freewheeling diode	For vehicle fan
M1	Engine	Combustion and hot air fan
M3	Engine	Vehicle fan
P	Combination digital timer (1531)	Digital timer and setpoint encoder
R1	Resistor 620 Ω	Only with internal temperature sensor
S1	Heater control	Setpoint encoder switch
S2	Isolator switch, 1 or 2-pin	Emergency-Stop-switch
S3	Switch	On and for feed device
S4	Switch	Ventilation
S5	Switch	Rollover sensor
S6	Switch	CO ₂ setting
S7	Momentary-contact switch	Immediate heating button on remote control
S8	Battery isolator switch	
S9	Additional switch	Telestart switch-off function
V1	Diode	
V2	Diode	
X1	Plug connection, 2-pin	At Pos. A2 (ST B)
X2	Plug connection, 2-pin	At Pos. A2 (ST V)
X3	Plug connection, 2-pin	At Pos. A2 (ST U)
X4	Plug connection, 2-pin	At Pos. A2 (ST Z)
X5	Plug connection, 2-pin	At Pos. A2 (ST Y)
X6	Plug connection, 2-pin	At Pos. A2 (ST X)
X7	Plug connection, 12-pin	At Pos. A2 (ST1)
X8	Plug connection, 2-pin	
X9	Plug connection, 4-pin	At Pos. S1
X10	Plug connection, 2-pin	
X11	Plug connection, 2-pin	At Pos. Y1
X12	Plug connection, 12-pin	At Pos. P
Y1	Metering pump	
Y2	Solenoid valve	For feed device

**Legend for
Wiring Dia-
grams**



Shut-down on fault



Faults in individual heater components and malfunctions during the entire operation are recognized in the control unit.

The heater is shut down (fault lock-out) if:

- No or faulty start-up
- Temperature sensor defective
- Open or short circuit in overheating sensor
- Overheating sensor mounted incorrectly
- Break or short circuit in glow element
- Fan motor overloaded, blocked, short circuit or open circuit
- Fault in metering pump circuit or overheating protection (only during start-up phase)
- Undervoltage < 10.5 V or overvoltage > 16 V and longer than 20 sec. (on heaters with 12 V)
- Control unit defective
- Overheating
- Flame detector (only on petrol heater)

In case of overheating, the fuel feed is interrupted. A run-on is carried out as with manual shut-down. Following the run-on, the heater is in the fault lock-out mode. The overheating is indicated by the operation indicator flashing 10 times.

Eliminate fault cause.

For fault release, briefly switch the heater off and then on again (at least 2 sec.).

If serious malfunctions, such as overheating, or no start-up occurs increasingly frequently, then the heater is permanently locked (F12 or F13) and can only be returned to operation following repairs by specially trained Webasto experts.

Fault code output:

Note:

When equipped with a heater control, fault code output is carried out after a malfunction occurs by the switch-on check/fault code display flashing. After 5 rapid flashing pulses, the fault code output is carried out with a sequence of long flashing pulses in accordance with the numbers in the table below. When equipped with a combination timer, a fault output appears in the display of the digital timer after a fault occurs. When using the heater control, the fault number is indicated by the operating indicator lamp flashing:



Display	Fault Code
F00	Control unit fault/incorrect data record/customer bus faulty
F01	No start-up (after 2 starting attempts)/no flame formation
F02	Flame failure (repeated >3)
F03	Undervoltage or overvoltage
F04	Premature flame detection
F05	Flame detector (petrol heater) open or short circuit
F06	Open or short circuit in temperature sensor
F07	Open or short circuit in metering pump
F08	Open circuit, short circuit, overloading or blocking in fan motor
F09	Break or short circuit in glow element
F10	Overheating: As a result, continuous heater lock-out
F11	Open or short circuit in overheating sensor
F12	Heater unit lock-out
F13	Continuous heater lock-out
F14	Overheating sensor in incorrect position
F15	Open circuit in setpoint encoder

Legend for
Fault Code
Output

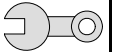

Final Work

WARNING!

Reassemble the disassembled components in reverse order. Check all hoses, clamps and all electrical connections for firm seating. Insulate and tie back all loose lines.

Only use manufacturer-approved coolant. Spray the heater components with anti-corrosion wax (Tectyl 100K, Order No. 111329).

- **Connect the battery**
- **Set digital timer, teach telestart transmitter**
- **Place the "Switch off parking heater before refuelling" signboard in the area of the filling connection pieces**
- **See installation instructions for initial start-up and function test**



Webasto AG
Postfach 80
D-82132 Stockdorf / Germany
National Hotline: 01805 93 22 78
(14 Cent aus dem deutschen Festnetz)
Hotfax: 0395 5592 353
Hotmail: hotline@webasto.de
<http://www.webasto.de>

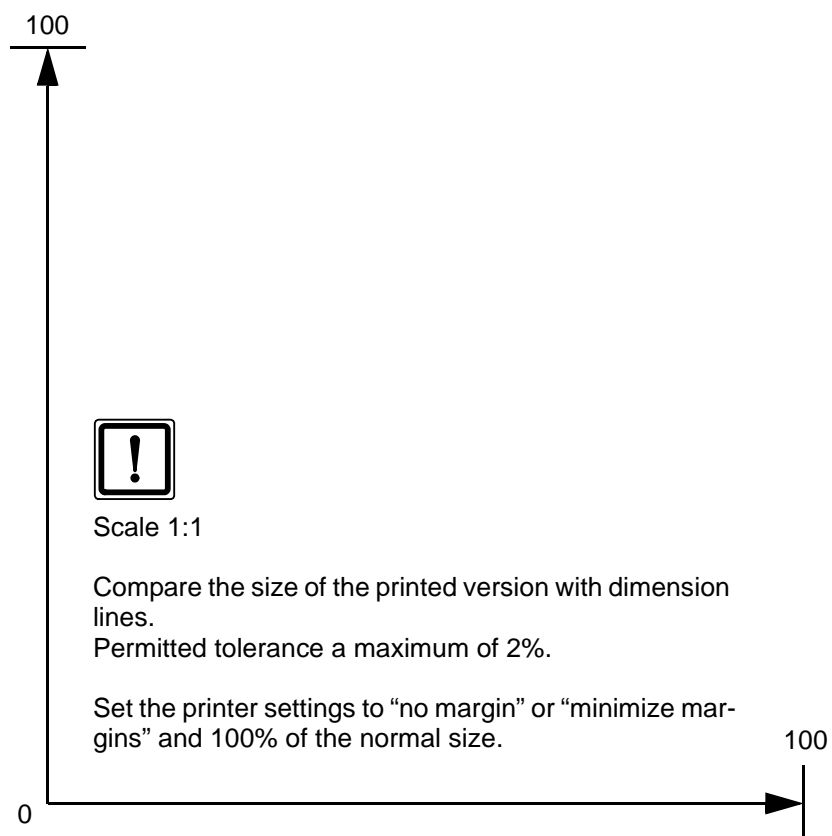
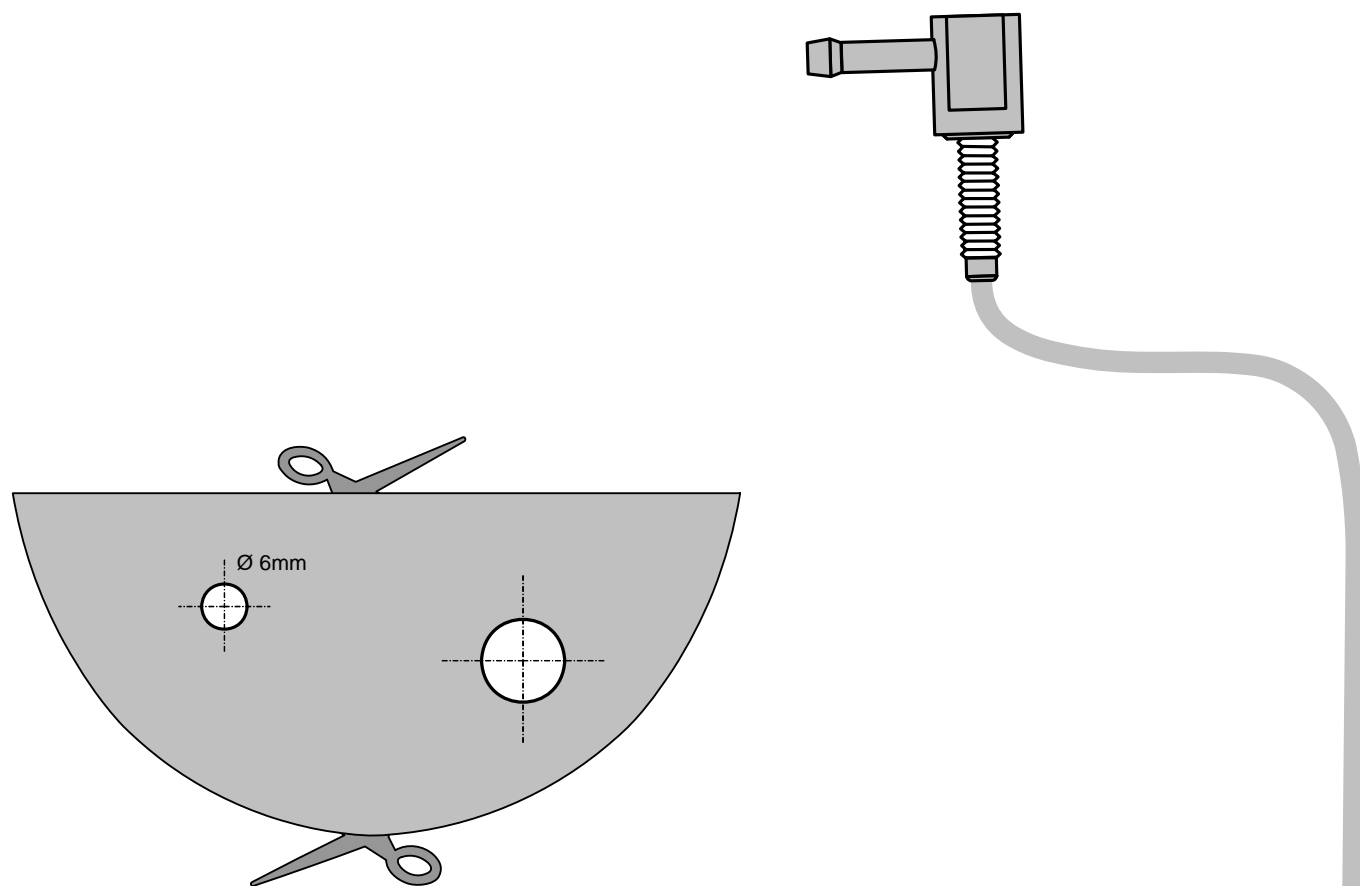

Operating Instructions for End Customer

Please remove page and add to the vehicle operating instructions.

Only for vehicles with standard heater control and Telestart!

On vehicles with parking heater or parking heater from factory, the fuel level may not be below 1/4 of a tank for proper operation of the *Air Top 2000 ST* air heater!

Before parking the vehicle, make the following settings:

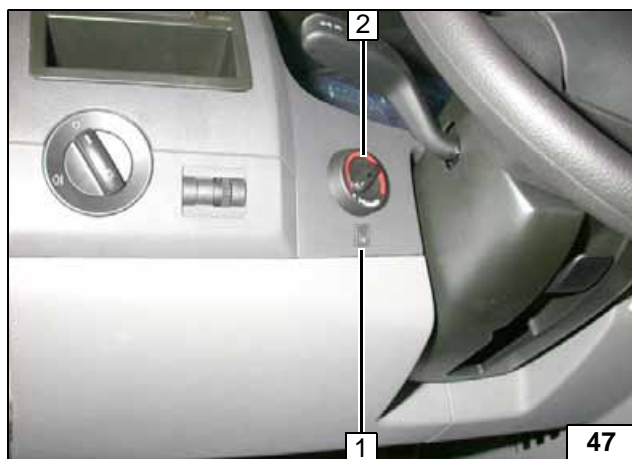

- 1 Switch to "Open"
- 2 Temperature on standard heater control to "warm" (start-up after switch-on on hand-held transmitter)

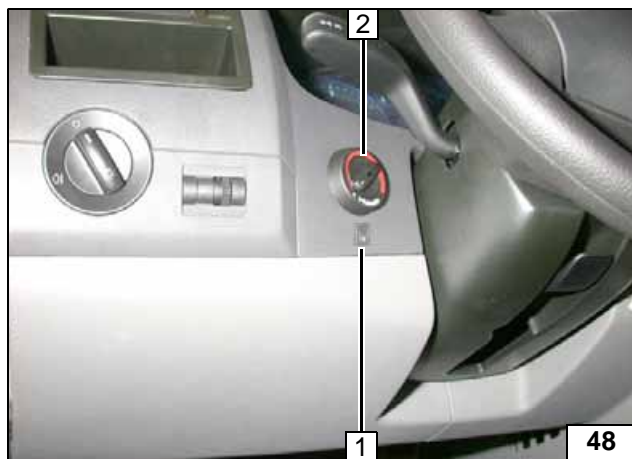

- 1 Switch to "Close"
- 2 Temperature on standard heater control to "warm" (immediate start-up)

**Version A:
Switching
on heater
with Tele-
start**

**Version B:
Switching
on heater
with heater
control**